

Service manual

Type: combi NoFrost

Contents

Introduction.....	3
Product overview.....	4
Option and settings (display-touch).....	6
Anomalies signalling (display-touch).....	8
Option and settings (leds-touch).....	9
Anomalies signalling (leds-touch).....	8
Components description.....	11
Components values.....	13
Manual test procedure (display-touch).....	17
Manual test procedure (leds-touch).....	18
Dismounting instructions.....	19
Lower Hinge regulating.....	26
Drain rubber procedure	27
Troubleshooting-----	28
Wiring diagrams.....	29
Exploded view.....	30

This service manual describes COMBI no frost freezer types **display-touch / leds-touch**

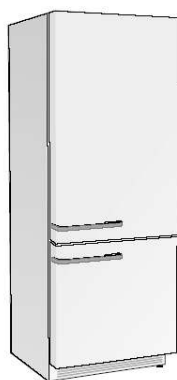

Introduction

You are holding the service manual for the RF2583NF - RF2483NF generation of touch control cooling product.

There are different types of combi no frost product touch series: . The following page presents the different versions, to help you identify the machine types. The variants are named differently from market to market. The type designation is the most important factor for identifying the appliances type. The type designation can be found on the label applied to the appliance which is located at the left lower side of the appliance.

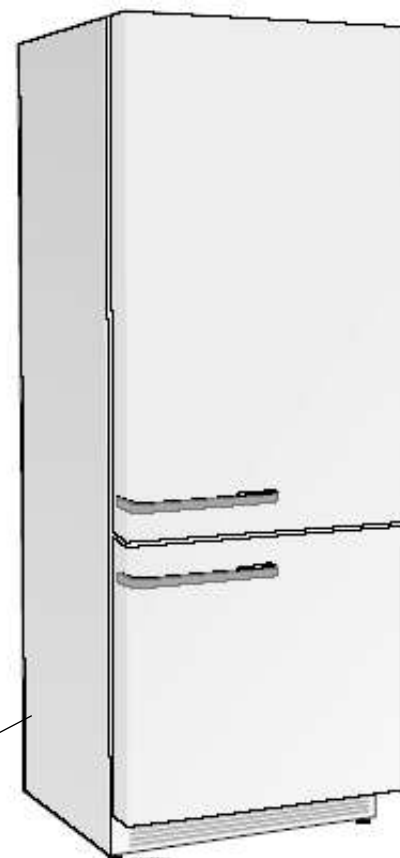

2014 01 99999 - 0329999999 - 03

Year

Week

Progr. nr.

Model code

Factory id

It should be easy to service a cooling product. It is important that you, as a service technician, are given the conditions to be able to carry out work in an efficient and satisfactory way. Our hope is that this service manual is a useful tool for your daily work.

Type overview

Combi no-frost touch display version

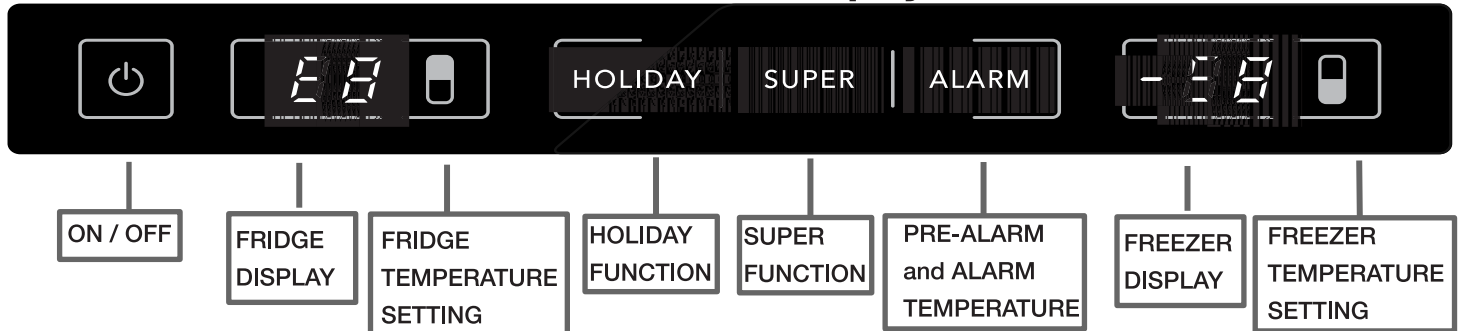

Appliance is provided with an electronic module touch version placed inside the control panel that allow to select various temperature positions available and within the range -16°C to -24°C for the freezer compartment and from $+2^{\circ}\text{C}$ to $+7^{\circ}\text{C}$ for the fridge compartment.

It also allows of the fast freezing function for which the operation phase is visible by the white back light of the related icon "SUPER" on the module. The fast freezing function can be manually deactivated by touching again the activation switch or it will be automatically deactivated after 30 hours from when was started. Appliance also is provided of the freezer temperature pre-alarm function and of the temperature freezer alarm function which are described in the following paragraphs..

Combi no frost touch leds version

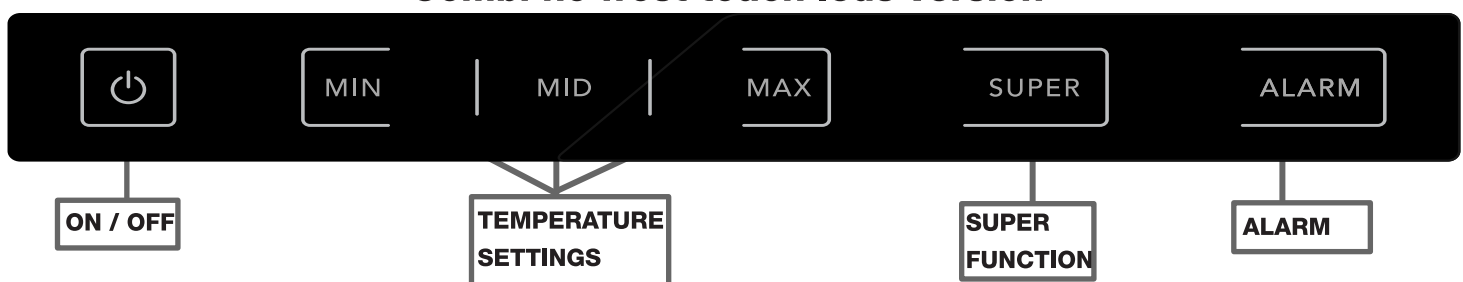

Appliance is provided of a touch electronic module version 5 leds placed in the control panel and allow to select the various temperature positions available: "MIN, MID and MAX".

It also allows of the fast freezing function for which the operation phase is visible by the white back light of the related icon "SUPER" on the module. The fast freezing function can be manually deactivated by touching again the activation switch or it will be automatically deactivated after 30 hours from when was started.

Type overview

Internal view of the appliance



Internal view of the appliance



freezer compartment



freezer compartment

No frost radiator view in the freezer compartment











Option and settings touch display type



Touch display type



-  **ON / OFF**
-  **FRIDGE DISPLAY**
-  **FREEZER DISPLAY**
-  **FRIDGE COMPARTMENT POWER SWITCH (ON/OFF)**
FRIDGE TEMPERATURE ADJUSTMENT
FRIDGE DOOR OPEN ALARM (DEACTIVATION)
-  **FREEZER TEMPERATURE ADJUSTMENT**
FREEZER DOOR OPEN ALARM (DEACTIVATION)
-  **HOLIDAY FUNCTION**
-  **SUPER FUNCTION**
-  **PRE-ALARM - ALARM**
FREEZER TEMPERATURE

CAUTION

Whenever the product has been lying horizontally during transportation, it should be left to stand upright for at least six hours before it is switched on, otherwise it may be noisy when it is in operation.

NOTE

Before plugging the appliance in, make sure that the power supply voltage corresponds to the value shown on the product data plate ("See the section Electrical connection"). Plug the appliance into the electricity mains supply. The display will flash, showing the default temperature set by the manufacturer (7°C for the refrigerator area, -16°C for the freezer area).

SWITCHING ON THE APPLIANCE

The appliance is switched on by touching the  symbol for at least 0.5 seconds.

It is possible to switch off only the refrigerator compartment by touching the  symbol for 4 seconds (the "--" symbol appears on the display);

the freezer compartment may be switched off by touching the  symbol for at least 4 seconds.

NOTE: in this case, the refrigerator compartment and all the display symbols are also automatically switched off.



TIP!

With room temperatures between 20°C and 25°C, we suggest setting the refrigerator temperature at +5°C and the freezer temperature at -18°C.

The freezer and refrigerator temperature is also depending on how often the doors are opened and the quantity of food contained inside the product.



SETTING THE TEMPERATURE OF THE FREEZER AREA

The freezer display indicates the actual internal temperature of the freezer compartment ranging from +20°C to -40°C; if the temperature exceeds +20°C, the symbol "H" appears on freezer display. Freezer temperature can be adjusted by touching the  symbol; temperatures between -16°C and -24°C can be set.

When the refrigerator is switched on, if you touch the  symbol the set temperature value will flash on the display for 6 seconds. To set a new temperature, touch the  symbol and, while the display is flashing, touch the same symbol  repeatedly until the desired temperature value has been reached; the new setting will be stored after the display has stopped flashing (6 seconds).

SETTING THE TEMPERATURE OF THE REFRIGERATOR AREA



The refrigerator display indicates the actual internal temperature of the refrigerator compartment ranging from 0°C to 19°C; if the temperature exceeds 19°C, the symbol "H" appears on the display. Refrigerator temperature can be adjusted by touching the  symbol; temperatures between 2°C and 7°C can be set.

When the refrigerator is switched on, if you touch the  symbol the set temperature value will flash on the display for 6 seconds. To set a new temperature, touch the  symbol and, while the display is flashing, touch the same symbol  repeatedly until the desired temperature value has been reached; the new setting will be stored after the display has stopped flashing (6 seconds).

Option and settings touch display type

Touch display type

CHECKING THE PROGRAMMED TEMPERATURE

If the  symbol (refrigerator area) and the  symbol (freezer area) are touched once, the programmed temperature will flash on the display for 6 seconds; after, the actual temperature inside the compartments will be displayed. The set functions remain stored in the memory of the appliance, even in the event of a power cut or when the appliance is disconnected from the electricity supply; upon start-up, the last temperature setting for both compartments will flash on the display.

HOLIDAY FUNCTION

The "**HOLIDAY**" function may be used during periods of prolonged inactivity (for example, if all users go on holiday). This function saves electricity as it takes into account the fact that the door of the appliance will not be opened at all during this period and maintains a temperature inside the refrigerator which is suitable for the storage of food. To activate this function, simply touch the text "**HOLIDAY**" for at least 0.5 seconds; the text will be lit up in white. The function may only be deactivated manually, by touching the text "**HOLIDAY**" for 0.5 seconds. While the appliance is operating in "**HOLIDAY**" mode, all other settings are temporarily disabled.

SUPER FUNCTION

The Super function was designed to reduce the temperature inside the refrigerator compartment in the shortest possible time; if you touch the text "**SUPER**" for at least 0.5 seconds the function will be activated for a period of 7 hours, during which time the text "**SUPER**" will be lit up in white. After this 7-hour period, the Super function will be deactivated automatically. However, if you wish to manually deactivate the function before the 7-hour period has elapsed, simply touch the text "**SUPER**" for at least 0.5 seconds; when the function has been deactivated the text "**SUPER**" will no longer be illuminated.

While the appliance is operating in Super mode, all other freezer compartment settings are temporarily disabled.

PRE-ALARM MODE AND FREEZER TEMPERATURE

The pre-alarm mode is activated when the temperature inside the freezer compartment reaches a value higher than -12°C (for example, -11°C). This may occur in the following situations:

- a large amount of unfrozen food has been placed in the freezer (see freezing modes);
- the door has been open for an extended period of time;
- the electricity supply has been cut off for a prolonged period of time;
- the appliance has malfunctioned.

The pre-alarming mode is indicated by the temperature appearing intermittently on the freezer display, by the flashing white **ALARM** symbol and by the audible alarm.

The audible alarm may be disabled by touching the **ALARM** text; in this case the pre-alarm mode indicator of the flashing temperature on the display remains active and the **ALARM** text will remain lit in a fixed manner instead of flashing. The pre-alarm mode is disabled automatically, but only when the temperature of the freezer compartment falls below -12°C ; at this point the **ALARM** text will no longer be illuminated, while the temperature will stop flashing and remain lit in a fixed manner on the display.



FREEZER TEMPERATURE ALARM



The alarm function was designed with the aim of warning the user that, due to some external cause (for example, a power cut, the door has been left open, etc.) the food kept in the freezer compartment has reached a temperature higher than $+1^{\circ}\text{C}$ and has therefore completely thawed out.

In this case, the **freezer temperature alarm** mode is enabled and flashes on the display, along with the highest temperature detected inside the compartment; the **ALARM** text is illuminated in red and the audible alarm is also activated.

The display memory (maximum temperature reached) is important because, if power is cut off and then restored, the appliance will continue operating as normal; this could result in food which had previously thawed out being refrozen.

DOOR OPEN ALARM

Every time the door is opened the  symbol (refrigerator) and/or the  symbol (freezer) lights up in white, in a fixed manner; if the door remains open for over 2 minutes, the "**Door Open**" buzzer alarm sounds; it may be deactivated in one of the 2 following ways:

- by closing the door, both the buzzer and the visible alarm signal deactivate;
- if the  symbol (for the refrigerator door) or the  symbol (for the freezer door) is touched, only the buzzer deactivates, while the white-lit visible alarm signal starts flashing.

INTERNAL LIGHT

Every time the door is opened, the light inside the refrigerator compartment is switched on; if the door is opened for an extended period of time, the light switches off automatically after 5 minutes. To switch it back on, simply close the door and open it again.

MALFUNCTION MANAGEMENT

If the symbols "**E**", "**E-**", "**-E**", appear on the refrigerator-freezer display, the appliance is guaranteed to function for a few days, but the Technical Assistance Centre should be contacted immediately.

Anomalies and signalling touch display type

Touch display type

Checking and procedures --- ANOMALIES MANAGING --- (troubleshooting)

SIGNAL ON THE DISPLAY: "E" or "-E" or "E-"

If display shows the flashing symbol "E" or "-E" or "E-" , this means that a temperature sensor is defective:

Flashing signal "E" shown in place of the fridge temperature display, indicates a defect of the temperature sensor for the fridge compartment .

Flashing signal "-E" shown in place of the freezer temperature display, indicates a defect of the defrosting sensor

Flashing signal "E-" shown in place of the freezer temperature display, indicates a defect of the temperature sensor for freezer compartment.

Solution of the problem: to verify the ohm values of the defective sensor in relation to the values shown in the data sheet of the related sensor present inside this manual. (if necessary replace the sensor)

Note: In this condition the appliance runs a pre-set emergency cycle that guarantee the functioning of the appliance for some days but the defective sensor must be replaced as soon as possible.

POSSIBLE ANOMALIES OF FUNCTIONING FOR THE APPLIANCE ICE FORMATION ON NO-FROST RADIATOR

- To check the door is perfectly closed and no air could go inside the appliance across the door gasket.
- To check the presence of the black rubber tube on the aspiration tube at the back side of the appliance and that it is well inserted on the hole at the back side wall of the appliance: to check that this point is well insulated.
- To check for possible obstructions of the water drain rubber tube at the lower side of the no-frost radiator kit and check, at the same time, its right functioning by verifying the perfect closing of the rubber when the system is running.
- To check the electrical continuity for thermofuses by using the related procedure attached to this manual.
- To check the right functioning for the heating element by using the related procedure attached to this manual.
- To check the right functioning for the defrosting phase by using the related procedure for the forced activation of the defrosting phase attached to this manual.

Option and settings touch leds type

Touch leds type

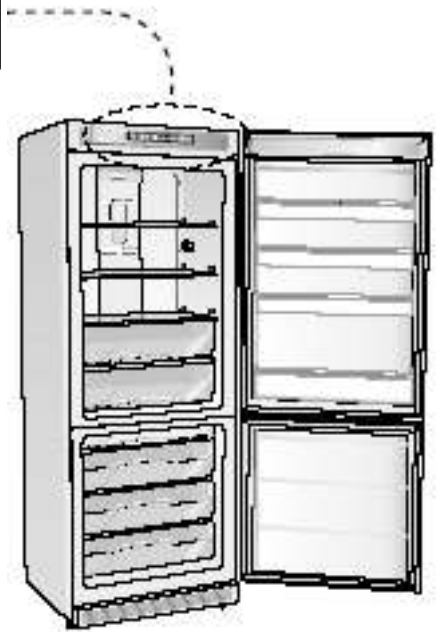

 ON / OFF

 |  |  TEMPERATURE ADJUSTMENT

 SUPER FUNCTION

 FUNCTION ALARM

CAUTION

Whenever the product has been lying horizontally during transportation, it should be left to stand upright for at least six hours before it is switched on, otherwise it may be noisy when it is in operation.

NOTE

Before plugging the appliance in, make sure that the power supply voltage corresponds to the value shown on the product data plate. Plug the appliance into the electricity mains supply.

SWITCHING THE APPLIANCE ON

Switch the product on by touching the  symbol for at least 0.5 seconds; activation will be confirmed by the text "MID", which will light up in white.

The appliance starts functioning after 30 seconds; the refrigerator and freezer compartments cannot function individually, as they are powered by a single compressor; the appliance is switched off by touching the  symbol for 5 seconds; at this point, all display texts will disappear.

SWITCHING THE APPLIANCE ON

3 separate temperatures may be set (indicated by the text "MIN - MID - MAX").

MIN indicates a less cold temperature inside the refrigerator-freezer compartment;

MID indicates a medium temperature inside the refrigerator-freezer compartment;

MAX indicates a colder temperature inside the refrigerator-freezer compartment.

To change the settings, touch the desired symbol (MIN – MID – MAX) for at least 0.5 seconds; the new setting will be confirmed by the illumination in white of the selected option.

N.B.: an option should be selected after taking into account the frequency with which the door is opened, the temperature of the room in which the appliance is installed and the quantity of food contained inside the product.

For room temperatures of between 20 - 25°C, we recommend the "MID" setting.

To switch the product off, simply touch the  symbol for at least 4 seconds.

Option and settings touch leds type

Touch leds type

SUPER FUNCTION

The Super function was designed to reduce the temperature inside the refrigerator compartment in the shortest possible time; if you touch the text **"SUPER"** for at least 0.5 seconds the function will be activated for a period of 27 hours, during which time the text **"SUPER"** will be lit up in white. After this 27-hour period, the Super function will be deactivated automatically. However, if you wish to manually deactivate the function before the 27-hour period has elapsed, simply touch the text **"SUPER"** for at least 0.5 seconds; when the function has been deactivated the text **"SUPER"** will no longer be illuminated. While the appliance is operating in Super mode, all other freezer compartment settings are temporarily disabled.

FREEZER TEMPERATURE ALARM

The temperature alarm mode is activated when a temperature higher than -12°C (for example, -11°C) is detected inside the freezer compartment. This may occur in the following situations:

- a large amount of unfrozen food has been placed in the freezer (see freezing modes);
- the door has been open for an extended period of time;
- the electricity supply has been cut off for a prolonged period of time;
- the appliance has malfunctioned.

The alarm mode is indicated by the flashing red **ALARM** text and by an audible alarm. The audible alarm may be disabled by touching the **ALARM** text for 3 seconds; in this case the alarm remains active and is indicated by the red **ALARM** text, which will stop flashing and remain lit in a fixed manner.

The alarm is disabled automatically, but only when the temperature of the freezer compartment falls below -12°C (for example, -13°C); when this happens, the **ALARM** text will no longer be illuminated.

INTERNAL LIGHT

Every time the door is opened, the light inside the refrigerator compartment is switched on; if the door is opened for an extended period of time, the light switches off automatically after 5 minutes. To switch it back on, simply close the door and open it again.

MALFUNCTION MANAGEMENT

Should the **MIN - MID - MAX** texts flash simultaneously or in sequence, the fridge is guaranteed to work for a few days, but the Technical Assistance Centre should be contacted immediately.

Anomalies management --- (troubleshooting)

Sensor malfunction signalling

In case that the three symbols **MIN-MID-MAX** are flashing, it means that one of the sensor is defective:

Flashing signal in sequence of the three leds indicates a fault for defrosting sensor.

Flashing signal simultaneous of the three leds indicates a fault of the freezer compartment sensor.

Solution of the problem: to verify the ohm values of the defective sensor in relation to the values shown in the datasheet of the related sensor present inside this manual. (if necessary replace the sensor)

Note: In this condition the appliance runs a pre-set emergency cycle that guarantee the functioning of the appliance for some days but the defective sensor must be replaced as soon as possible.

Components description

(freezer compartment - no frost radiator kit)

Not restorable thermo-fuses

This is a thermic protection device that disable the electricity power for the heating element to avoid the overheat in case is reached the temperature of 72° degrees.
The device is not restorable so in case of intervention it must be replaced with a new one because if broken the heating element is not powered.

NOTE: More recently made appliances can use a new kind of thermo-fuse with integrated defrosting sensor placed at the same position of actual thermo-fuses.

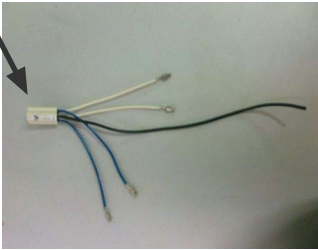

Not restorable thermofuses with integrated defrosting sensor.

Defrosting end sensor

This sensor signals the end for defrosting-time to the electronic module.
In touch leds version also sends the freezer compartment temperature alarm.



internal connector

Freezer compartment sensor: (only available in touch display models)

This sensor sends the signal for the freezer compartment temperature: the sensor also sends the signal of alarm for freezer compartment temperature in touch display models. The sensor is only present in touch display models.

Note: touch led model does not get the freezer compartment temperature sensor and the compressor activity is controlled by the fridge compartment temperature sensor.

Components description

(reed and magnet position)



• Reed position

On the electronic module inside the control panel is mounted the reed that receive the signal from the magnet when the door is opening: the magnet is placed inside the upper cover of the fridge door. The signal, when the fridge door is opening, stops the fan in the freezer compartment.

Procedure of checking in case of malfunctioning.
(fridge compartment reed)

To check the right functioning of the reed on the electronic module for this appliance we can proceed as follows:

- When the door is opened, move a magnet the nearest possible to the reed position to check if the reed detects the signal of the magnet. The symbol "opened door" on the module must switch off when the magnet is in front of the reed and the motorfan must instead start again if compressor is running.

In case that no signals are detected will be necessary to replace the reed.

Check for the presence of the magnet inside the upper cover of the door by moving another magnet or a metallic object the nearest possible to the magnet position on the door: in case of absence of the magnet inside the cover of the door no signal could be sent to the reed every time the door is closed.

• Magnet position

At the internal upper part of the door cover for the fridge compartment is mounted the magnet that when move under the control panel sends the signal to the reed to stop the motorfan in the freezer compartment and to start it again at the closing of the door.



• Reed and magnet position (Freezer compartment)

both reed and magnet are only available on touch display model

the reed is mounted at the right side of the freezer compartment and when the door is opening, sends the signal to stop the fan in the freezer compartment. The magnet is mounted at the left side of the inner door..

Reed position

Magnet position

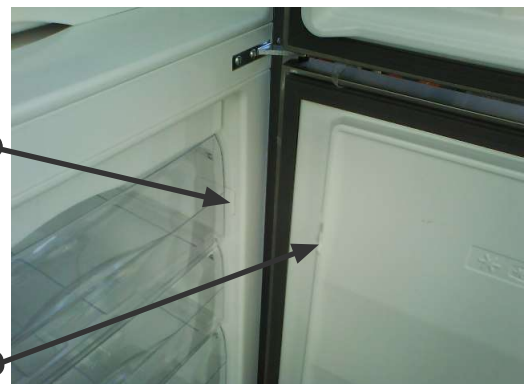

Components values

(Components - datasheet)

- Freezer compartment temperature sensor
- Defrosting sensors

- ref. nr. F12496 OHM values detected at the related temperature -rev. 001

°C	△	OHM
15	±0.6	4225
14	±0.6	4426
13	±0.6	4648
12	±0.6	4863
11	±0.6	5099
10	±0.6	5348
9	±0.6	5611
8	±0.6	5888
7	±0.6	6182
6	±0.6	6491
5	±0.4	6818
4	±0.4	7164
3	±0.4	7529
2	±0.4	7916
1	±0.4	8325
0	±0.4	8758
-1	±0.4	9216
-2	±0.4	9701
-3	±0.4	10215
-4	±0.4	10759
-5	±0.4	11337
-6	±0.6	11949
-7	±0.6	12598
-8	±0.6	13288
-9	±0.6	14019
-10	±0.6	14795
-11	±0.7	15620
-12	±0.7	16497
-13	±0.7	17429
-14	±0.7	18420
-15	±0.7	19475
-16	±0.8	20596
-17	±0.8	21791
-18	±0.8	23063
-19	±0.8	24418
-20	±0.8	25862
-21	±0.9	27042
-22	±0.9	29045
-23	±0.9	30797
-24	±0.9	32668
-25	±0.9	34666
-26	±1	36800
-27	±1	39082
-28	±1	41521
-29	±1	44131
-30	±1	46921
-31	±1	49910
-32	±1	53111
-33	±1	56541
-34	±1	60218
-35	±1	64161

WARNING! Values shown at the side view are exclusively related to the freezer compartment temperature sensor or defrosting sensor part numbers listed below in this page.

**651014205 502055700 SONDA BATTERIA AMB-FREEZER NO-FROST ECO
651014206 502055800 SONDA BATT-FREE FIN-SBRINAM NO-FROST EC
651014210 502056300 SONDA BATT-FREE FIN-SBRINAM GO34NFH
651053307 502071400 SONDA BATTERIA AMB-FREEZER GCS29-30 NFH
651053227 502075600 SONDA BATTERIA AMB-FREEZER GO43NFH
651053228 502075700 SONDA BATT-FREE FIN-SBRINAM GO43NFH
651055530 502079800 SONDA BATTERIA L=800 A-FREE GCS29-30NFH
651059426 502085200 SONDA AMB-FREEZER LU=700 GCS20NFH GCS29**

Verifying procedure

- Disconnect the appliance from main electricity supply.
- Place a thermometer the nearest possible to the head of the sensor to be checked.
- Find the point of connection of the sensor.
- after the temperature is stabilized so that thermometer and the compartment sensor will be at the same temperature, read the temperature shown by the thermometer previous placed near the sensor and, at the same time, check with a tester the OHM value for the sensor detectable on the sensor wires on the jst connector.
- Check the correct OHM value of the sensor relative to the real temperature verified by the thermometer by following the list of OHM values in agree with the real temperature of the sensor detected in that moment.

Components values

(Components - datasheet)

- Defrosting sensor with integrated thermo-fuses -

FRD145 --- ref. nr. F12998 OHM values detected at the related temperature -rev. 001

°C	△	OHM
15	±0.6	4225
14	±0.6	4426
13	±0.6	4648
12	±0.6	4863
11	±0.6	5099
10	±0.6	5348
9	±0.6	5611
8	±0.6	5888
7	±0.6	6182
6	±0.6	6491
5	±0.4	6818
4	±0.4	7164
3	±0.4	7529
2	±0.4	7916
1	±0.4	8325
0	±0.4	8758
-1	±0.4	9216
-2	±0.4	9701
-3	±0.4	10215
-4	±0.4	10759
-5	±0.4	11337
-6	±0.6	11949
-7	±0.6	12598
-8	±0.6	13288
-9	±0.6	14019
-10	±0.6	14795
-11	±0.7	15620
-12	±0.7	16497
-13	±0.7	17429
-14	±0.7	18420
-15	±0.7	19475
-16	±0.8	20596
-17	±0.8	21791
-18	±0.8	23063
-19	±0.8	24418
-20	±0.8	25862
-21	±0.9	27042
-22	±0.9	29045
-23	±0.9	30797
-24	±0.9	32668
-25	±0.9	34666
-26	±1	36800
-27	±1	39082
-28	±1	41521
-29	±1	44131
-30	±1	46921
-31	±1	49910
-32	±1	53111
-33	±1	56541
-34	±1	60218
-35	±1	64161

WARNING! Values shown at the side view are exclusively related to the defrosting sensor part numbers listed below in this page.

651058271 50208000 TERFUS DOPPIO-72° +SONDA GO2110-251 0 GE
651057164 502080100 TERFUS DOPPIO-72° +SONDA GCS29-30NF H GE
651058902 502080200 TERFUS DOPPIO-72° +SONDA GDX41NFH G ENER

Verifying procedure

- Disconnect the appliance from main electricity supply.
- Place a thermometer the nearest possible to the head of the sensor to be checked.
- Find the point of connection of the sensor.
- after the temperature is stabilized so that thermometer and the compartment sensor will be at the same temperature, read the temperature shown by the thermometer previous placed near the sensor and, at the same time, check with a tester the OHM value for the sensor detectable on the sensor wires on the jst connector.
- Check the correct OHM value of the sensor relative to the real temperature verified by the thermometer by following the list of OHM values in agree with the real temperature of the sensor detected in that moment.

Components values

- Fridge compartment temperature sensor

- ref. nr. **F10622** OHM values detected at the related temperature -rev. 001

°C	△	OHM
20	±1.3	12474
19	±1.3	13040
18	±1.3	13636
17	±1.4	14263
16	±1.4	14923
15	±1.4	15618
14	±1.4	16350
13	±1.4	17120
12	±1.5	17932
11	±1.5	18788
10	±1.5	19691
9	±1.5	20643
8	±1.6	21648
7	±1.6	22708
6	±1.6	23828
5	±1.6	25011
4	±1.6	26260
3	±1.7	27580
2	±1.7	28976
1	±1.7	30452
0	±1.7	32014
-1	±1.7	33696
-2	±1.8	35479
-3	±1.8	37370
-4	±1.8	39376
-5	±1.8	41505
-6	±1.8	43765
-7	±1.9	46165
-8	±1.9	48715
-9	±1.9	51426
-10	±1.9	54308
-11	±1.9	57285
-12	±2	60447
-13	±2	63806
-14	±2	67376
-15	±2	71172
-16	±2	75210
-17	±2.1	79507
-18	±2.1	84081
-19	±2.1	88953
-20	±2.1	94143
-21	±2.1	99643
-22	±2.2	105506
-23	±2.2	111758
-24	±2.2	118428
-25	±2.2	125546
-26	±2.2	133147
-27	±2.3	141267
-28	±2.3	149945
-29	±2.3	159224
-30	±2.3	169149

WARNING! Values shown at the side view are exclusively related to the fridge compartment temperature sensor part numbers listed below in this page.

651014082 502024400 SONDA AMB-FRIGO LU=1400 GDX41NFH
651014094 502027200 SONDA AMB-FRIGO LU=600 S-CON GO27B- GO27
651014095 502027300 SONDA SCHIUM LU=950 S-CON GFC34H
651014096 502027400 SONDA AMB-FRIGO LU=820 S-CON GO23BH
651051209 502030100 SONDA SCHIUM LU=900 C-ROS GO2110NFH
651014105 502030400 SONDA AMB-FRIGO LU=1250 S-CO GLS38F H
651014118 502034200 SONDA SCHIUM LU=650 C-ROS IGO28NFH
651014161 502047300 SONDA AMB-FRIGO L=1400 S-CON GO2210 BH
651014190 502053600 SONDA AMB-FRIGO LU=1900 SMEG ZGDX41 NFH
651014208 502056000 SONDA AMB-FRIGO LU=780 S-CONN GO211 ONF
651014248 502064300 SONDA SCHIUM LU=1700 10K GL34FH
651061075 502083200 SONDA AMB-FRIGO LU=1100 S-CONN GO2110
651014209 502056200 SONDA AMB-FRIGO LU=920 GO34NFH
651061038 502085300 SONDA AMB-FRIGO LU=1250 GO2210BH A+ +

Verifying procedure

- Disconnect the appliance from main electricity supply.
- Place a thermometer the nearest possible to the head of the sensor to be checked.
- Find the point of connection of the sensor.
- after the temperature is stabilized so that thermometer and the compartment sensor will be at the same temperature, read the temperature shown by the thermometer previous placed near the sensor and, at the same time, check with a tester the OHM value for the sensor detectable on the sensor wires on the jst connector.
- Check the correct OHM value of the sensor relative to the real temperature verified by the thermometer by following the list of OHM values in agree with the real temperature of the sensor detected in that moment.

Components values

(Components - datasheet)

WARNING! Values shown in this page are exclusively related to the heating element and the thermo-fuses for this appliance.

Heating element and thermo-fuses OHM values

A fast checking for the right functioning of the heating element and the thermo-fuses can be done by detecting the OHM value at the 10 pin jst connector that is connected to the module in the control panel:

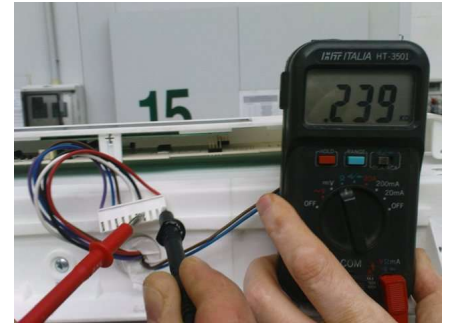
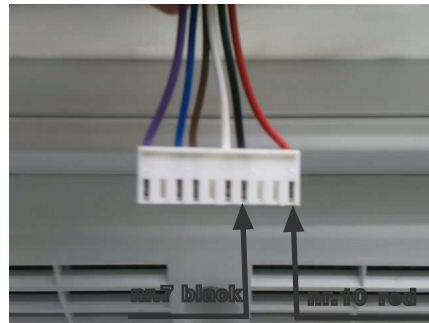

Remove the jst connector and detect the ohm value between red and black wire as shown in the picture above: if we find a value of about 240ohm it means that the heating element and the thermo-fuses are correctly running. In case we do not find any value instead, or we find a very different value, it means that the heating element or one or both the thermo-fuses, are broken.

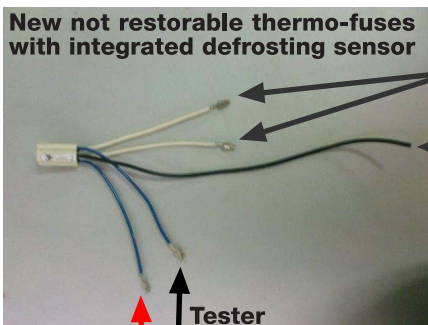

Tester
If we find continuity between the two blue wires this means the thermo-fuses is running. Note: with thermo-fuses connected to the heating element on these wires will be detected the OHM value of the heating element

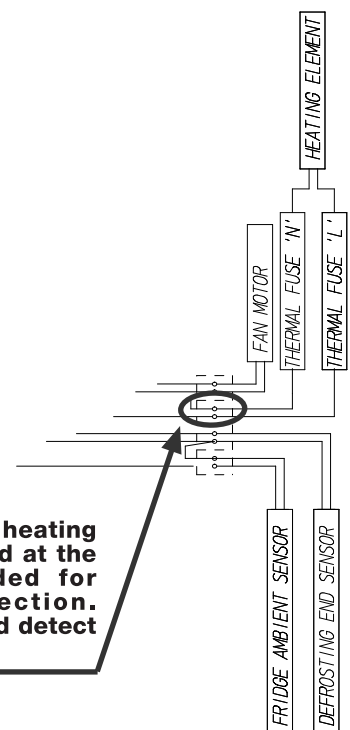

The same ohm value of the heating element can also be detected at the internal connector provided for the thermo-fuses connection. Disconnect the connector and detect the ohm value.

Manual test procedure DISPLAY-TOUCH type ~~Touch display type~~ (Manual test procedure) Touch display type

Autotest procedure to check the right functioning of the electronic module components

Manual test activation: Touch display type procedure RF2583NF GO2110NFH - CB11.200

1- Switch off the electronic module by touching the button Off/Standby

2/3- Keep touching for 4 seconds about the button "Super": a sound of a beep will confirm the access to manual test mode, the damper element will open and close, door fridge led is on:
Are immediately shown in sequence on the digits all the numbers from 0 to 9 to verify the right functioning of the display and the symbol "opened door" switches on if the appliance door is opened.

4- Then is automatically checked the temperature sensor of the fridge compartment: in case of error will be shown in the fridge display the related message "E" provided by the data sheet in relation to the defective sensor detected. If no errors are detected the display will remain switched off and we can proceed to the following step.

5- Then is automatically checked the temperature sensor of the freezer compartment: in case of error will be shown on the freezer display the related message "E-" provided by the data sheet in relation to the defective sensor detected. If no errors are detected the display will remain switched off and we can proceed to the following step.

6- Then is automatically checked the defrosting sensor at the freezer compartment: in case of error will be shown in the freezer display the related message "-E" provided by the data sheet in relation to the defective sensor detected. If no errors are detected the display will remain switched off and we can proceed to the following step.

Checking the right function of the buttons:

7- touch the "FRIDGE DOOR" symbol: a beep sounds to confirm the right function of the button. Fridge door led is on. (test ok, go on to the next step)

8- touch the "FREEZER DOOR" symbol: a beep sounds to confirm the right function of the button. Fridge door led is on. (test ok, go on to the next step)

9- Checking the right function of the fridge reed (fridge compartment) :
touch the symbol "off/stand-by": at the touch on the button a beep sounds to confirm the right functioning for the function, door fridge led is on. move a magnet in front of the fridge reed position and verify that when the magnet is in front of the reed, it will light off the "fridge door" symbol on the display. When the magnet is removed the symbol must switch on. (test ok, go on to the next step)

fridge reed position



10- Checking the right function of the freezer reed (freezer compartment) :
touch the symbol "off/stand-by": at the touch on the button a beep sounds to confirm the right functioning for the function, door fridge led is on. Open and close the freezer door: when the door is opened, it will light off the "freezer door" symbol on the display. When the door is closed the symbol led must switch on. (test ok, go on to the next step)

Freezer Reed position

Magnet position

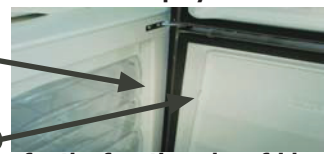

11- Check the functions "HOLIDAY":
touch the "HOLIDAY" button: at the touch on the button a beep sounds to confirm the right functioning for the function, door fridge led is on. It switches on the back light of the "HOLIDAY" symbol. (test ok, go on to the next step)

12- Check the functions "SUPER":
touch the "SUPER" button: at the touch on the button a beep sounds to confirm the right functioning for the function, door fridge led is on. It switches on the back light of the "SUPER" symbol. (test ok, go on to the next step)

13- Check the functions "ALARM": (red alarm led)
Touch the "ALARM" button. At the touch of the button a beep sounds and confirm the right functioning for the function. Will light on the back red light of the "ALARM" symbol, red alarm led is flashing, led "SUPER" is on, led door is on. (test ok, go on to the next step)

14- Check the functions "ALARM": (white alarm led)
Touch the "ALARM" button again. At the touch of the button a beep sounds and confirm the right functioning for the function. Will light on the back white light of the "ALARM" symbol, white alarm led is flashing, led "SUPER" is on, led door is on. (test ok, go on to the next step)

Checking the electrical load signals sent by the electronic module to the various components:

note: in this phase the load to each component will be sent for a period of 2 minutes after that the manual test will exit for time-out occurred.

15- Touch the button "OFF/Stand-by": At the touch of the button a beep sounds and confirm the right functioning for the button, led "SUPER" is on, led "ALARM" is flashing, led fridge door is on. The module sends the electrical load to the compressor, display shows "CO" and the compressor start to run for about 2 minutes. Touch again the button within 2 minutes to go on to next step. (test ok, go on to the next step)

16- Touch the button "OFF/Stand-by": At the touch of the button a beep sounds and confirm the right functioning for the button, led "SUPER" is on, led "ALARM" is flashing, led fridge door is on. The module sends the electrical load to the lamp, freezer display shows "LA" and the lamp start to run for about 2 minutes. Touch again the button within 2 minutes to go on to next step. (test ok, go on to the next step)

17- Touch the button "OFF/Stand-by": At the touch of the button a beep sounds and confirm the right functioning for the button, led "SUPER" is on, led "ALARM" is flashing, led fridge door is on. The module sends the electrical load to the fan, freezer display shows "FA" and the fan starts to run for about 2 minutes. Touch again the button within 2 minutes to go on to next step. (test ok, go on to the next step)

18- Touch the button "OFF/Stand-by": At the touch of the button a beep sounds and confirm the right functioning for the button, led "SUPER" is on, led "ALARM" is flashing, led fridge door is on. The module sends the electrical load to the heating element, freezer display shows "HE" and the heating element starts to run for about 2 minutes. (test ok, go on to the next step)

19- Touch again the button "OFF/Stand-by" for exit from manual test after 10 seconds: otherwise autotest mode automatically exit after 120 seconds of time-out

Manual test procedure LEDS-TOUCH type

(Manual test procedure)

Touch leds type

Autotest procedure to check the right functioning of the electronic module components

Touch leds type procedure: RF2483NF - GO2110NFH - CB11.500

Manual test activation:

- 1- Switch off the electronic module by touching the button Off/Standby
- 2- Keep touching for 4 seconds about the button "Super": a sound of a beep will confirm the access to manual test mode. Led "MIN" light is on. (test ok, go on to the next step)
- 3- Touch the button "MID": At the touch of the button a beep sounds and confirm the right functioning for the button, led "MID" is on. (test ok, go on to the next step)
- 4- Touch the button "MAX": At the touch of the button a beep sounds and confirm the right functioning for the button, led "MAX" is on. (test ok, go on to the next step)
- 5- Touch the button "SUPER": At the touch of the button a beep sounds and confirm the right functioning for the button, led "SUPER" is on. (test ok, go on to the next step)
- 6- Touch the button "ALARM": At the touch of the button a beep sounds and confirm the right functioning for the button, led "ALARM" flashes. (test ok, go on to the next step)
- 7- Touch the symbol OFF/Standby: At the touch of the button a beep sounds and confirm the right functioning for the button. It is checked the right functioning for the fridge compartment sensor: if a defect is detected it is shown the error by simultaneous flashing of the leds "MIN, MID and MAX". otherwise, if no error is found, no light will be on and we can touch the OFF/Standby button to go on to the next step.
- 8- Touch the symbol OFF/Standby: At the touch of the button a beep sounds and confirm the right functioning for the button. It is checked the right functioning of the defrosting sensor: if a defect is detected it is shown by the flashing in sequence of the leds "MIN, MID and MAX": otherwise, if no defect is found, no light will be on and we can touch the OFF/Standby button to go on to the next step.

Checking the right function of the buttons:

- 9- touch the "MIN" symbol: a beep sounds to confirm the right function of the button. (test ok, go on to the next step)
- 10- touch the "MID" symbol: a beep sounds to confirm the right function of the button. (test ok, go on to the next step)
- 11- touch the "MAX" symbol: a beep sounds to confirm the right function of the button. (test ok, go on to the next step)
- 12- touch the "SUPER" symbol: a beep sounds to confirm the right function of the button. (test ok, go on to the next step)
- 13- touch the "ALARM" symbol: a beep sounds to confirm the right function of the button. (test ok, go on to the next step)

Fridge Reed checking:

Touch again the button "OFF/Stand-by" and within 5 seconds move a magnet in front of the reed position a sound of a beep will confirm the reading signal for the magnet. This step ends within 10 seconds.

reed position



Checking the electrical load signals sent by the electronic module to the various components:

note: in this phase the electrical load to each component will be sent for a period of 2 minutes after that the manual test will exit for time-out occurred.

- 15- Touch the button "OFF/Standby": At the touch of the button a beep sounds and confirm the right functioning for the function. the module sends the electrical load to the compressor, "MIN" led will light on and compressor starts to run for about 2 minutes. (test ok, go on to the next step)
- 16- Touch again the button "OFF/Standby": At the touch of the button a beep sounds and confirm the right functioning for the function. the module sends the electrical load to the lamp, "MID" led will light on and lamp starts to run for about 2 minutes. (test ok, go on to the next step)
- 17- Touch again the button "OFF/Standby": At the touch of the button a beep sounds and confirm the right functioning for the function. the module sends the electrical load to the fan, "MAX" led will light on and fan starts to run for about 2 minutes. (test ok, go on to the next step)
- 18- Touch again the button "OFF/Standby": At the touch of the button a beep sounds and confirm the right functioning for the function. the module sends the electrical load to the heating element, "SUPER" led will light on and heating element starts to run for about 2 minutes. (test ok, go on to the next step)

A further pressure on the button OFF/Standby will exit the manual test: otherwise, exit from manual test mode automatically happens after 120 seconds of time-out.

Dismounting procedure

(no frost radiator kit area access)

No frost radiator kit opening

Freezer internal view

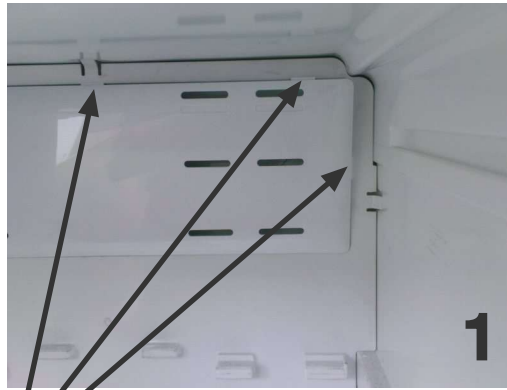

Air diffuser fixing hooks pressure mounted

Diffuser removed - view

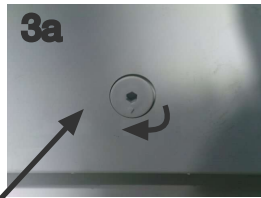

3 /3a- align the arrow towards the lower side of the appliance by rotating a quarter of a round the plastic exagonal screw: then pull the plastic cover to remove it.



4/4a- to remove the conveyer make free the hooks at both the upper side and the right side by lightly lifting the hook.

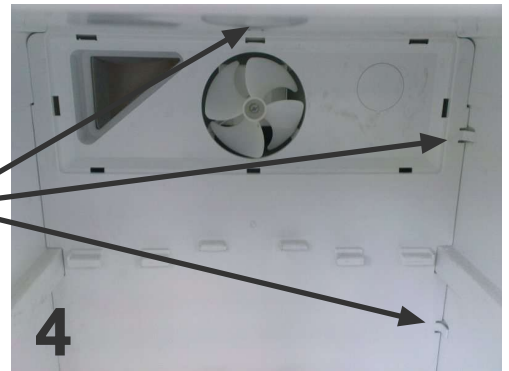

Internal connector



Radiator kit opened - see details at page 11

To extract the conveyer after have removed the hooks pull it and rotate from right side.

Before to extract completely the conveyer from the freezer compartment you must disconnect the fan wire from the internal connector.

Dismounting procedure

Motorfan replacing (no frost radiator kit area access)

pull to extract the fan

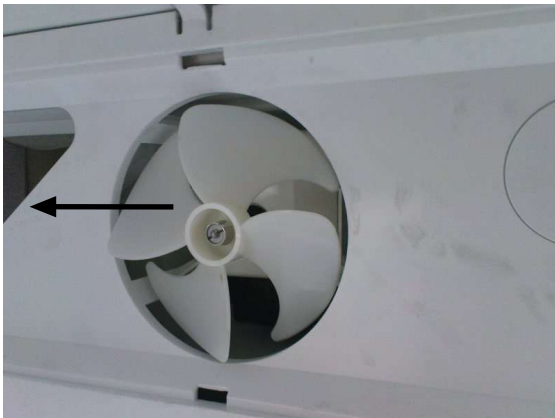

fan removed

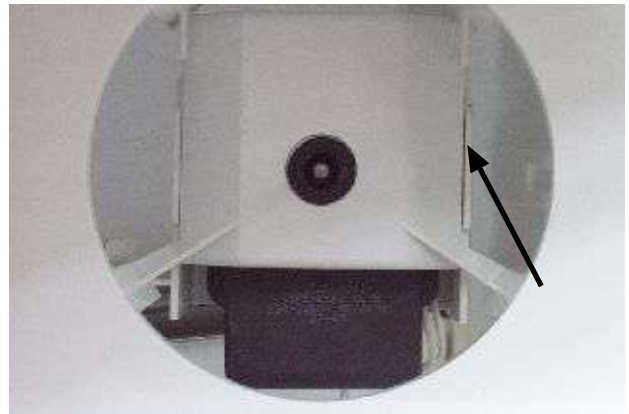

Once we have removed the fan we are able to see the motorfan box and we can dismount it: to do this we must widen the lateral hooks and then pull the motorfan box cover: see details at the next picture.

widen to free the hook

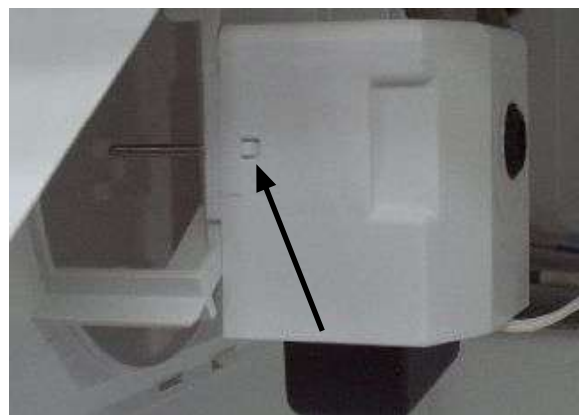

hook side view

Dismounting procedure

Motorfan replacing (no frost radiator kit area access)

Take the new motor, put it inside the cover and let the wires go towards the back side internal connector. Connect the wires to the relative connections (see details in the related wiring diagram)

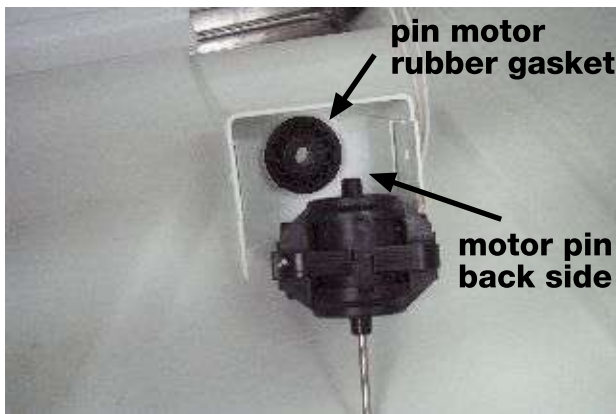

Place the plastic pin at the back side of the motor fan inside the rubber gasket and then reassemble the box to the air diffuser by mounting the steel axis of the motor fan in the specific place on the support gasket placed on the diffuser.

Reassemble making sure that the plastic hooks are well mounted: then mount the fan leaving about 2.5mm of the steel axis out: make sure that the fan does not touch anything or be noisy by making it run manually.

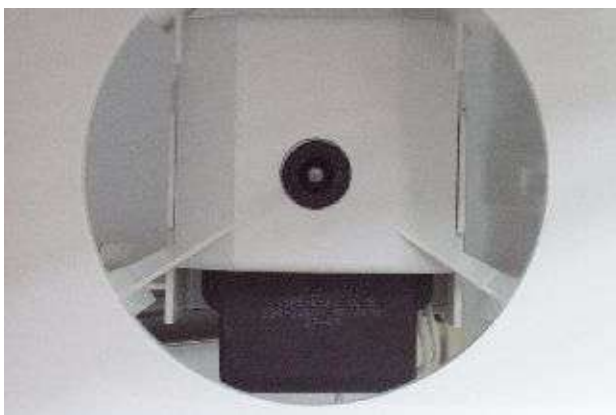

assembled motor fan set

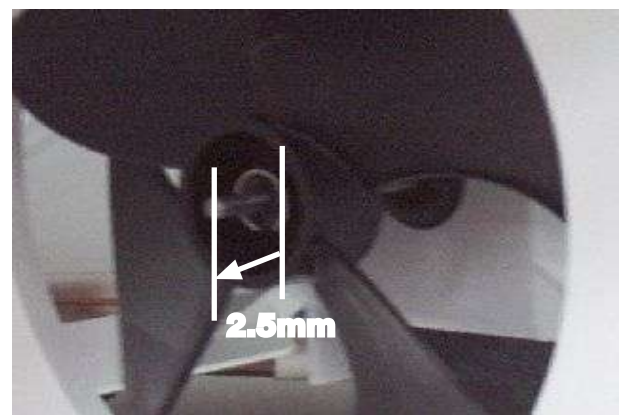

motor fan steel axis external side distance about 2.5mm

Dismounting procedure

(fridge compartment - air diffuser)
(lamp - lamp thermal protector)

Fridge compartment internal view

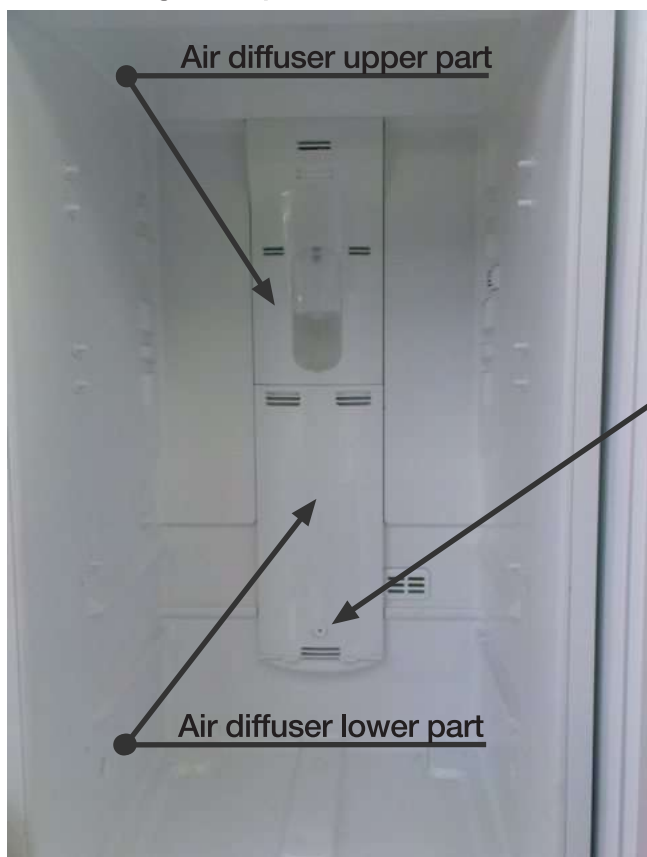

1- align the arrow towards the lower side of the appliance by rotating a quarter of a round the plastic exagonal screw: then pull the plastic cover to remove it.



Lateral side hooks



Lower diffuser part
internal insulating



Air diffuser upper part

Fridge compartment air diffuser
upper part



when removing the lower diffuser part we can see the fixing screw for the upper part diffuser.



Lateral side hooks

Remove the lateral hooks then pull down the diffuser to remove it

Dismounting procedure

(fridge compartment - air diffuser)
(damper - lamp - lamp thermal protector)

Upper air diffuser removed:
damper element
(only provided for touch display models)



damper element fixing position

Lamp thermal protector



Fixing Adhesive strip for damper element

Lamp thermal protector

The restorable thermal protector is a device made to avoid the risk of over heating in the lamp area. It is restorable and it stops the power supply when it reaches about 70 degrees to close the circuit again at about 50 degrees. It is connected in series to the lamp and to detect its correct function it only needs to check the continuity with a tester when the lamp is normally working: continuity can also be detected at the lamp connector.



Lamp cover view



Lamp cover removing:
open this side

Dismounting procedure

Handle: Installation/replacing



1 - ASKO step 2 Handle view

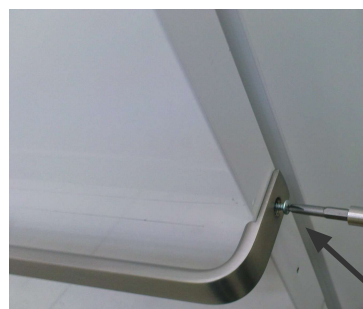

4 - Unscrew at the lateral side



2 - Fixing screw at the lower side (view)



5 - remove the handle



3 - Unscrew at the lower side



6 - remove the handle support

Dismounting procedure

Electronic module: Installation/replacing



1 -remove the closing cap of the hole's screw which are pressure mounted: then remove the fixing screws at both the lower sides of the control panel.



2 -lift the control panel to make free the fixing hooks at the lower side of the control panel support.

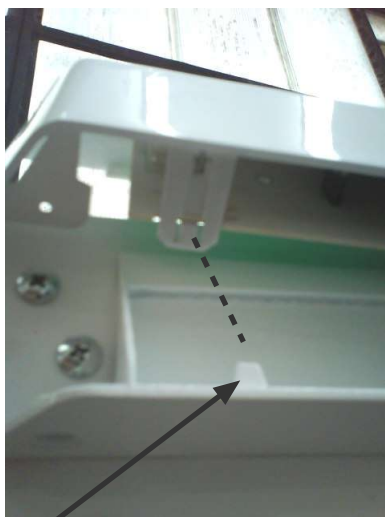

Frontal fixing hook inside the support



Lower Hinge regulating - (door alignment)

Door alignment is possible by regulating the lower hinge fixing the screw in the optimal position.

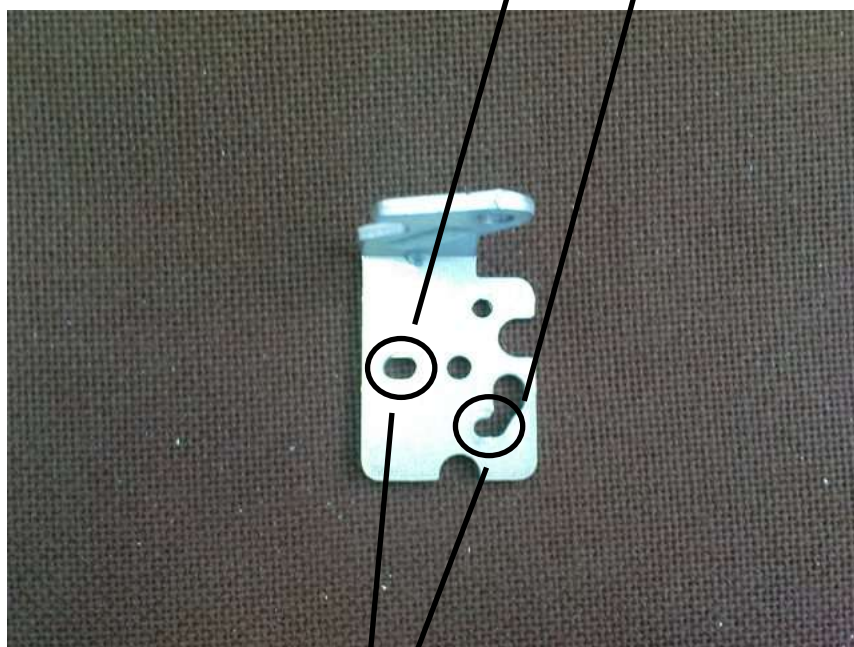

Door alignment
regulating holes

(Components - datasheet)

- Drain rubber discharge tube -

- ref. nr. F03059 drain rubber discharge tube -rev. 000



Appliance back side view:



Drain rubber discharge tube position detail:

Check for the right functioning of the Drain rubber discharge tube:

Drain rubber tube functioning provides, by the contact between the rims, to let come out the drain water and avoid the air access to the freezer compartment while the fun runs.



Dismount the Drain rubber discharge tube simply pulling it because it is pressure mounted:



Check that the rims at the lower side of the tube are perfectly in contact between them self and to avoid air access to the freezer compartment.



Clean the internal side of the rubber drain tube from any dirty which could interfere with the correct flow of the water drain.

Check the right functioning for both the rims of the drain tube by pushing at both the side of the rubber tube: the rims must open as shown in picture 4 and then close again when we stop to push at the sides. In some cases the rims could be attached between them self so we can detach them and do the opening test again.



Reassemble to the appliance the Drain rubber discharge tube.

Checking procedures (troubleshooting)

Checks and verifying procedures

ice accumulation on no-frost radiator

- 1- Make sure that no obstructions or occlusions are there in the water drain system and check the right functioning starting from the drain hole immediately under the no-frost radiator. In models provided with long discharge tube make sure of the presence of the round on the tube with siphon function to avoid air access from the external to inside the freezer compartment.
- 2 - Check if is there any air penetration towards the no-frost radiator area and make sure it is completely insulated from the external. (point of exit for the suction tube, possible anomalies for the gasket of the freezer door and of the insulation of the door and of the cabinet.

Verifying procedures

Check the absence of oxidations and humidity in the internal connector at the freezer compartment (at the back side connection box for the previous models that were provided). To check the right functioning for the thermofuses because, if those are interrupted, they compromise the functioning for the heating element: so, we must check the continuity of conduction on the thermofuses connector by following the indications on the wiring diagram of the related appliance we are checking. Once have done the previous operations it is necessary to make sure that, during the defrosting execution phase, it is sent the signal of power supply to the heating element. To do this check we must force the activation of defrosting phase. (see the instruction of activation for the defrosting phase following shown)

Forced activation for defrosting execution phase procedure.

Note: This procedure will active the defrosting execution time only if freezer is cold.

To activate the defrosting time, plug the appliance , let it run up to 10 minutes about, then unplug it from the power and plug again after 1 minute about. It will start the defrosting execution time and now it is possible to check with a tester in the internal connector (at the back side connection box for the older models), the power supply sent to the heating element's wire by following the wiring diagram. Last, make sure for good functioning of heating element.

Wiring diagram combi NoFrost Display-Touch

(Wiring diagram)
TOUCH-DISPLAY TYPE
ref. code 460618149

WIRING DIAGRAM 0021104FH TOUCH DISPLAY

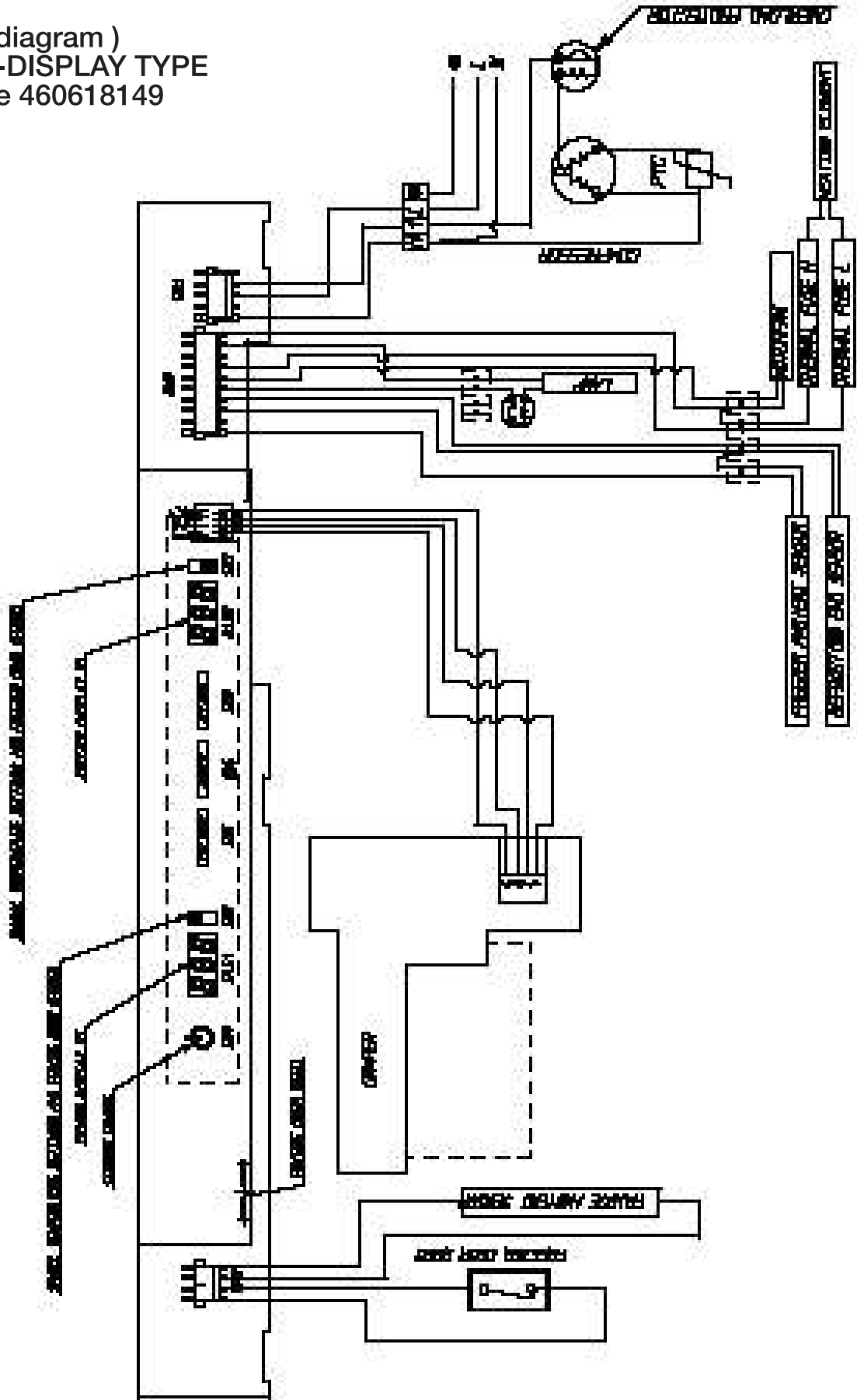

Wiring diagram combi NoFrost Leds-Touch

(Wiring diagram)
TOUCH-LEDS TYPE
ref. code 460618142

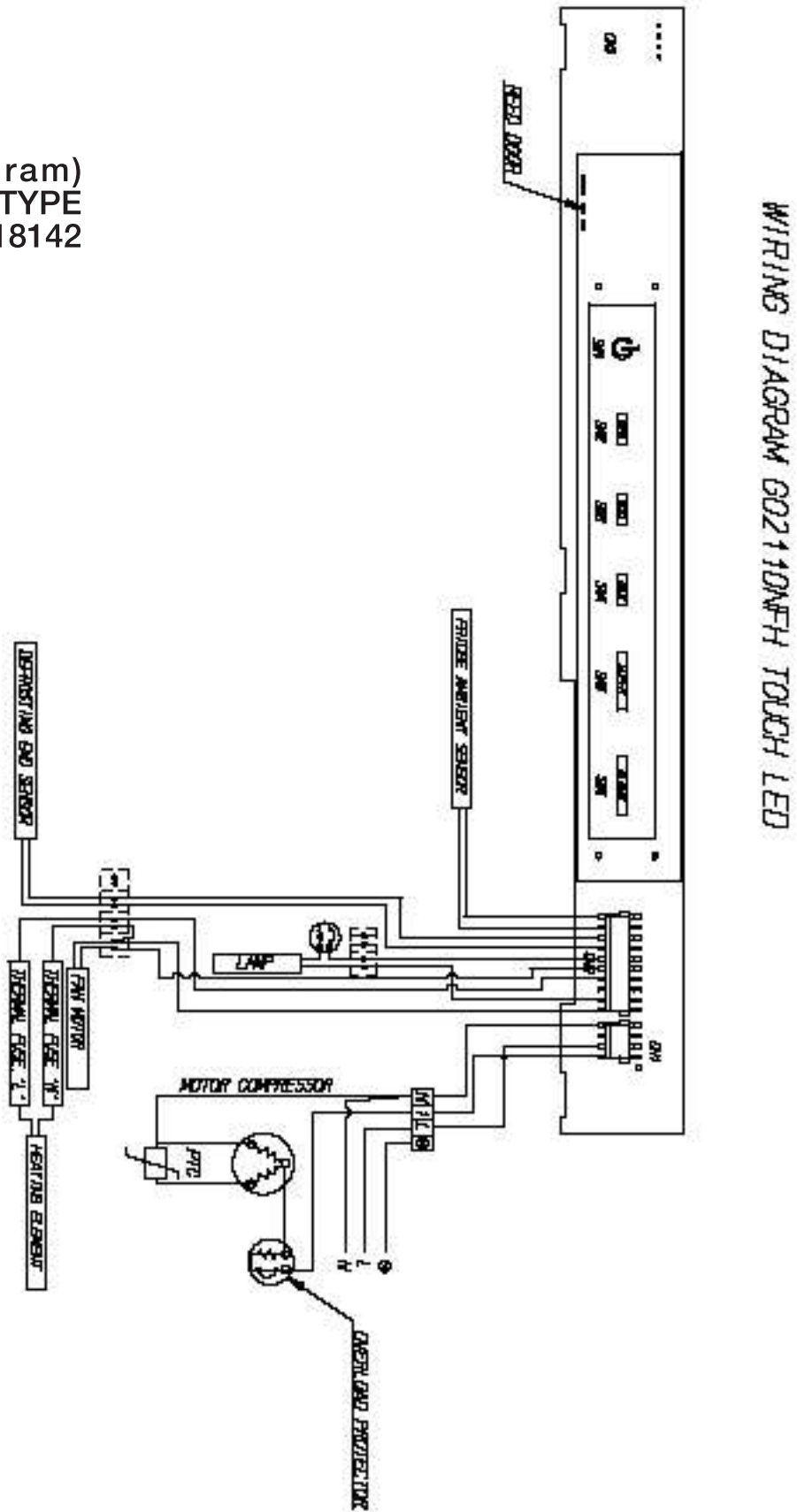

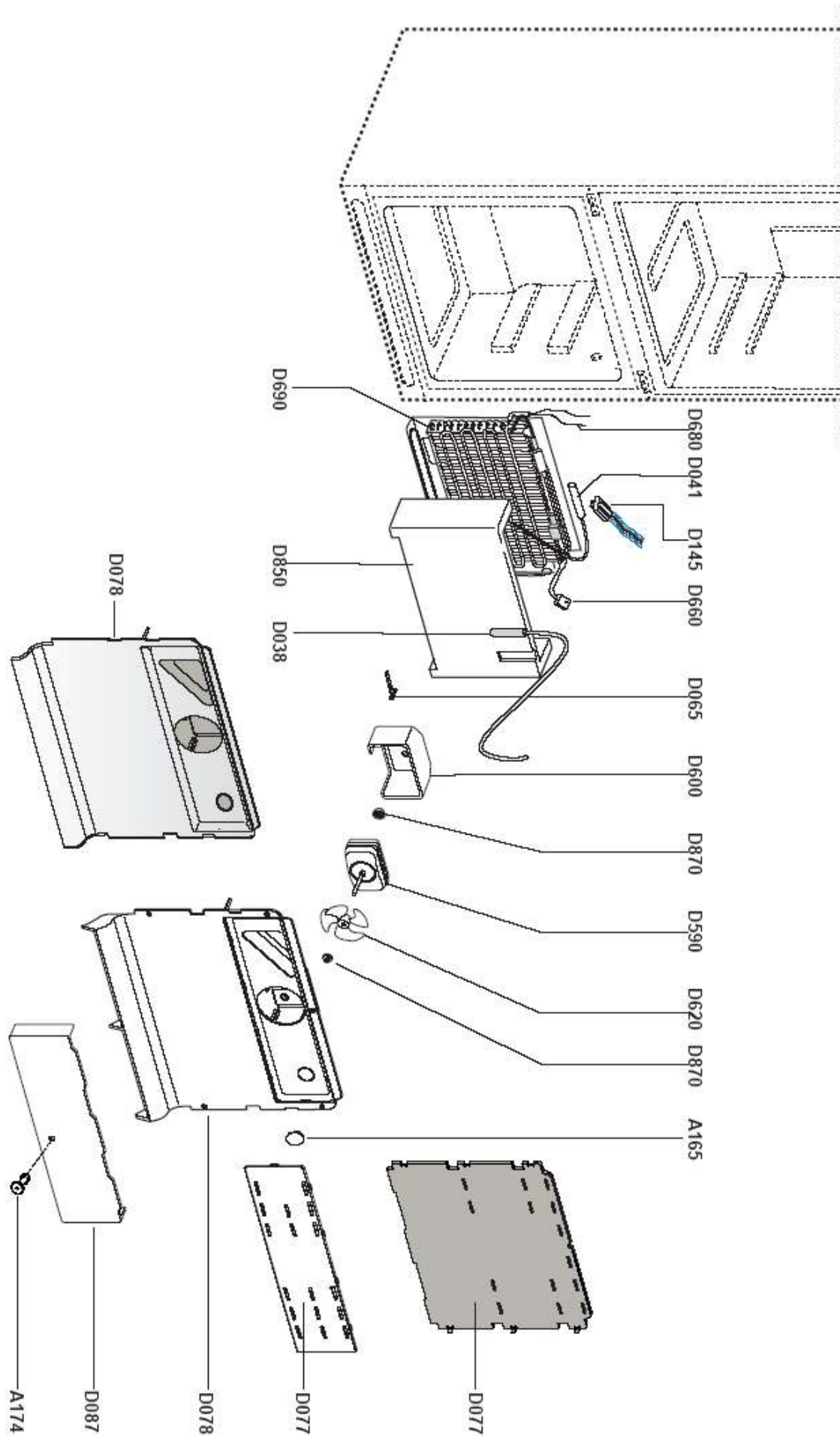

Checking procedures (troubleshooting)

Controlli e procedure di verifica:

accumulo di ghiaccio nella batteria

- 1- Accertarsi che non vi siano ostruzioni od occlusioni del sistema di scarico dell'acqua e verificarne il corretto funzionamento a partire dallo sgocciolatoio subito sotto la batteria. Nei modelli previsti di tubo di scarico lungo assicurarsi della presenza del giro sul tubo con funzione di sifone per evitare accesso di aria dall'esterno verso il comparto freezer.
- 2- Verificare eventuali penetrazioni di aria dall'esterno verso il gruppo batteria accertandone il completo isolamento dall'esterno. (punto di uscita del tubo di ritorno, anomalie della chiusura della guarnizione porta freezer o dell'isolamento della porta e del mobile.

Procedure di verifica

Verificare l'assenza di ossidazioni e umidità nel connettore interno (nella scheda di connessione posteriore per i modelli precedenti che ne sono previsti). Verificare il funzionamento dei termofusibili che, qualora fossero interrotti, comprometterebbero il funzionamento della resistenza: pertanto verificare la presenza di continuità di conduzione sui contatti dei termofusibili seguendo le indicazioni dello schema elettrico relativo al prodotto che stiamo controllando.

Una volta compiute le operazioni precedenti occorre accertarsi che venga inviata alimentazione alla resistenza durante durante la fase di sbrinamento: per fare questo controllo dobbiamo attivare forzatamente la fase di sbrinamento. (vedere le istruzioni di attivazione forzata dello sbrinamento di seguito).

Procedura di attivazione forzata della fase di sbrinamento.

N.B. Questa procedura attiverà la fase di sbrinamento solo se il freezer è freddo.

Per attivare la fase di sbrinamento, inserire il cavo di alimentazione, lasciare funzionare il prodotto per 10 minuti circa, scollegare il cavo di alimentazione e ricollegarlo dopo avere atteso un minuto. Inizia così la fase di sbrinamento ed è possibile ora rilevare nel connettore interno (nella scheda di connessione posteriore per i modelli più vecchi) la tensione sui contatti della resistenza indicati nello schema elettrico. Verificare infine il funzionamento corretto della resistenza di sbrinamento.