

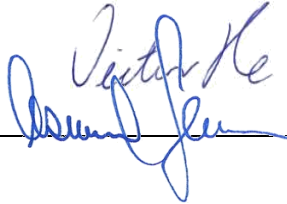
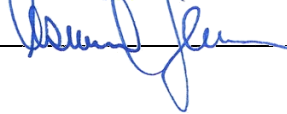

<p>TEST REPORT IEC 60335-2-6 Safety of household and similar electrical appliances Part 2: Particular requirements for stationary cooking ranges, hobs, ovens and similar appliances</p>	
Report Reference No.:	247713
Date of issue.....:	2013-12-09
Total number of pages.....:	118
CB Testing Laboratory	Nemko AS Phone: (+47) 22 96 03 30
Address.....:	Gaustadalléen 30, N-0373 Oslo, Norway
Applicant's name	Tecnowind S.p.A.
Address.....:	Via Piani Marischio, 19, I – 60044 Fabriano (AN), Italy
Test specification:	
Standard	IEC 60335-2-6:2002 (Fifth edition) + A1:2004 + A2:2008 in conjunction with IEC 60335-1:2010 (Fifth Edition)
Test procedure.....:	CB
Non-standard test method.....:	N/A
Test Report Form No.	IEC60335_2_6J
Test Report Form(s) Originator	LCIE.
Master TRF.....:	Dated 2013-05
<p>Copyright © 2013 IEC System for Conformity Testing and Certification of Electrical Equipment (IECEE), Geneva, Switzerland. All rights reserved.</p> <p>This publication may be reproduced in whole or in part for non-commercial purposes as long as the IECEE is acknowledged as copyright owner and source of the material. IECEE takes no responsibility for and will not assume liability for damages resulting from the reader's interpretation of the reproduced material due to its placement and context.</p> <p>If this Test Report Form is used by non-IECEE members, the IECEE/IEC logo and the reference to the CB Scheme procedure shall be removed.</p> <p>This report is not valid as a CB Test Report unless signed by an approved CB Testing Laboratory and appended to a CB Test Certificate issued by an NCB in accordance with IECEE 02.</p>	
Test item description	Hobs for building-in (Radiant hob elements)
Trade Mark	
Manufacturer.....:	Same as applicant
Model/Type reference	P58..... (see page 6-12 for model explanation)
Ratings.....:	5,1kW to 6,9kW 220-240V 2/3~ 380-415V 2N/3N~ 50/60Hz, Cl. I

Testing procedure and testing location:	
<input checked="" type="checkbox"/> CB Testing Laboratory:	Nemko AS
Testing location/ address.....:	Gaustadalléen 30, 0373 Oslo Norway
<input type="checkbox"/> Associated CB Laboratory:	
Testing location/ address.....:	
Tested by (name + signature).....:	Victor He 
Approved by (+ signature)	Asmund Jensen 
<input type="checkbox"/> Testing procedure: TMP	
Tested by (name + signature).....:	
Approved by (+ signature)	
Testing location/ address.....:	
<input type="checkbox"/> Testing procedure: WMT	
Tested by (name + signature).....:	
Witnessed by (+ signature).....:	
Approved by (+ signature)	
Testing location/ address.....:	
<input type="checkbox"/> Testing procedure: SMT	
Tested by (name + signature).....:	
Approved by (+ signature)	
Supervised by (+ signature).....:	
Testing location/ address.....:	
<input type="checkbox"/> Testing procedure: RMT	
Tested by (name + signature).....:	
Approved by (+ signature)	
Supervised by (+ signature).....:	
Testing location/ address.....:	

<p>List of Attachments (including a total number of pages in each attachment):</p> <ol style="list-style-type: none"> 1. EUROPEAN GROUP DIFFERENCES AND NATIONAL DIFFERENCES (16 pages) 2. Comparison of normal dimension and slim dimension (3 pages) 3. PHOTOGRAPH (31 pages) 4. COMPONENT LIST FOR ELECTRONIC CONTROL UNIT 3 (3 pages) 	
<p>Summary of testing:</p> <p>This test report is upgrade of test report no. 226179 due to add-in alternative components and upgrade of new edition test standard.</p>	
<p>Tests performed (name of test and test clause):</p> <p>The tested samples are found to comply with the requirements of the relevant product standards.</p> <p>The sample(s) tested complies with the requirements of standard which listed on first page and on summary of compliance with national differences.</p> <p>Marking label, user manual, packing text: Instructions and marking shall be in a language acceptable for the country where the equipment is to be used.</p> <p>Other product properties: Depending on the country where the equipment is to be used, national deviations may be considered. Samples of the modified product may be tested again according to relevant clauses of the product standard, modified by national deviations.</p>	<p>Testing location:</p> <p>Nemko AS Gaustadalléen 30 N-0373 Oslo Norway</p>
<p>Summary of compliance with National Differences</p> <p>List of countries addressed:</p> <p>CELENEC member countries.</p> <p><input checked="" type="checkbox"/> The product fulfils the requirements of following:</p> <p>EN 60335-2-6 2003 + A1:2003 + A2: 2008 + A11: 2010 + A12:2012 + A13:2013 used in conjunction with EN 60335-1:2012 EN 62233:2008</p>	

Copy of marking plate

The artwork below may be only a draft. The use of certification marks on a product must be authorized by the respective NCBs that own these marks.

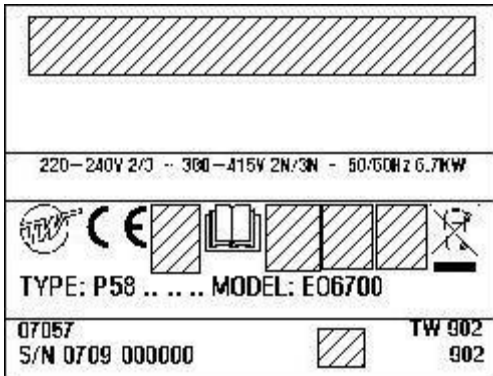

The marking plates for the other models are the same as above label except the model name and rating.

Calibration	All instruments used in the tests given in this test report are calibrated and traceable to national or international standards. Further information about traceability will be given on request.
Measurement uncertainty	Measurement uncertainties are calculated for all instruments and instrument set-ups given in this report. Calculations are based on the principles given in the standard EA-4/02 (Dec. 1999), IEC Guide 115:2007 and other relevant internal Nemko-procedures. Further information about measurement uncertainties will be given on request.
Evaluation of results	If not explicitly stated otherwise in the standard, the test is passed if the measured value is equal to or below (above) the limit line, regardless of the measurement uncertainty. If the measured value is above (below) the limit line, the test is not passed - ref IEC Guide 115:2007. The instrumentation accuracy is within limits agreed by IECEE-CTL.

Test item particulars	Hobs for building-in (Radiant hob elements)
Classification of installation and use	Built-in appliance (Recessed), unattended use
Supply Connection	Supply cord for permanent connection to fixed wiring; type X attachment
.....	:
Possible test case verdicts:	
- test case does not apply to the test object.....	: N/A
- test object does meet the requirement	: P (Pass)
- test object does not meet the requirement	: F (Fail)
Testing	
Date of receipt of test item	2013-10-16
Date (s) of performance of tests	2013-10-16 to 2013-10-19
General remarks:	
<p>The test results presented in this report relate only to the object tested. This report shall not be reproduced, except in full, without the written approval of the Issuing testing laboratory. "(see Enclosure #)" refers to additional information appended to the report. "(see appended table)" refers to a table appended to the report.</p> <p>Throughout this report a <input checked="" type="checkbox"/> comma / <input type="checkbox"/> point is used as the decimal separator.</p>	
Manufacturer's Declaration per sub-clause 6.2.5 of IEC60335-1:	
The application for obtaining a CB Test Certificate includes more than one factory location and a declaration from the Manufacturer stating that the sample(s) submitted for evaluation is (are) representative of the products from each factory has been provided	<input type="checkbox"/> Yes <input checked="" type="checkbox"/> Not applicable
When differences exist; they shall be identified in the General product information section.	
Name and address of factory (ies)	Tecnowind S.p.A. Via Piani Marischio, 19, I – 60044 Fabriano (AN), Italy

General product information:

The report applies to built-in hobs of the TYPE: P58..... (3 or 4 hob elements) which has the following electrical features:

- Power Input : From 5.1kW up to 6.9kW;
- Supply voltage : 220-240V 2/3 ~ or 380-415V 2N/3N ~ (with different connection)
- Frequency : 50/60Hz.

For appliances without electronic board, the temperature control is managed by thermostats integrated in each heating element.

In appliances with electronic board the temperature control is managed by electronic regulator and by thermostats integrated in each heating element.

The appliances are sold with supply cord (Type X attachment) and without plug. It is for permanent connection to supply mains

The following variants are covered by this test report:

No.	Type	Model	Rated Power	Rated Voltage
1.	P58.....	EO5100	5.1kW	220-240V 2/3 or 380-415V 2N/3N
2.	P58.....	EO5200	5.2kW	220-240V 2/3 or 380-415V 2N/3N
3.	P58.....	EO5300	5.3kW	220-240V 2/3 or 380-415V 2N/3N
4.	P58.....	EO5400	5.4kW	220-240V 2/3 or 380-415V 2N/3N
5.	P58.....	EO5410	5.4kW	220-240V 2/3 or 380-415V 2N/3N
6.	P58.....	EO5500	5.5kW	220-240V 2/3 or 380-415V 2N/3N
7.	P58.....	EO5600	5.6kW	220-240V 2/3 or 380-415V 2N/3N
8.	P58.....	EO5700	5.7kW	220-240V 2/3 or 380-415V 2N/3N
9.	P58.....	EO5800	5.8kW	220-240V 2/3 or 380-415V 2N/3N
10.	P58.....	EO5900	5.9kW	220-240V 2/3 or 380-415V 2N/3N
11.	P58.....	EO6000	6.0kW	220-240V 2/3 or 380-415V 2N/3N
12.	P58.....	EO6100	6.1kW	220-240V 2/3 or 380-415V 2N/3N
13.	P58.....	EO6200	6.2kW	220-240V 2/3 or 380-415V 2N/3N
14.	P58.....	EO6300	6.3kW	220-240V 2/3 or 380-415V 2N/3N
15.	P58.....	EO6400	6.4kW	220-240V 2/3 or 380-415V 2N/3N
16.	P58.....	EV5400	5.4kW	220-240V 2/3 or 380-415V 2N/3N
17.	P58.....	EV5500	5.5kW	220-240V 2/3 or 380-415V 2N/3N
18.	P58.....	EV5600	5.6kW	220-240V 2/3 or 380-415V 2N/3N
19.	P58.....	EV5700	5.7kW	220-240V 2/3 or 380-415V 2N/3N
20.	P58.....	EV5800	5.8kW	220-240V 2/3 or 380-415V 2N/3N
21.	P58.....	EV5900	5.9kW	220-240V 2/3 or 380-415V 2N/3N
22.	P58.....	EV6000	6.0kW	220-240V 2/3 or 380-415V 2N/3N

No.	Type	Model	Rated Power	Rated Voltage
23.	P58.....	EV6100	6.1kW	220-240V 2/3 or 380-415V 2N/3N
24.	P58.....	EV6200	6.2kW	220-240V 2/3 or 380-415V 2N/3N
25.	P58.....	EV6300	6.3kW	220-240V 2/3 or 380-415V 2N/3N
26.	P58.....	EV6400	6.4kW	220-240V 2/3 or 380-415V 2N/3N
27.	P58.....	RO5400	5.4kW	220-240V 2/3 or 380-415V 2N/3N
28.	P58.....	RO5500	5.5kW	220-240V 2/3 or 380-415V 2N/3N
29.	P58.....	RO5600	5.6kW	220-240V 2/3 or 380-415V 2N/3N
30.	P58.....	RO5700	5.7kW	220-240V 2/3 or 380-415V 2N/3N
31.	P58.....	RO5800	5.8kW	220-240V 2/3 or 380-415V 2N/3N
32.	P58.....	RO5900	5.9kW	220-240V 2/3 or 380-415V 2N/3N
33.	P58.....	RO6000	6.0kW	220-240V 2/3 or 380-415V 2N/3N
34.	P58.....	RO6100	6.1kW	220-240V 2/3 or 380-415V 2N/3N
35.	P58.....	RO6200	6.2kW	220-240V 2/3 or 380-415V 2N/3N
36.	P58.....	RO6300	6.3kW	220-240V 2/3 or 380-415V 2N/3N
37.	P58.....	RO6400	6.4kW	220-240V 2/3 or 380-415V 2N/3N
38.	P58.....	RV5400	5.4kW	220-240V 2/3 or 380-415V 2N/3N
39.	P58.....	RV5500	5.5kW	220-240V 2/3 or 380-415V 2N/3N
40.	P58.....	RV5600	5.6kW	220-240V 2/3 or 380-415V 2N/3N
41.	P58.....	RV5700	5.7kW	220-240V 2/3 or 380-415V 2N/3N
42.	P58.....	RV5800	5.8kW	220-240V 2/3 or 380-415V 2N/3N
43.	P58.....	RV5900	5.9kW	220-240V 2/3 or 380-415V 2N/3N
44.	P58.....	RV6000	6.0kW	220-240V 2/3 or 380-415V 2N/3N
45.	P58.....	RV6100	6.1kW	220-240V 2/3 or 380-415V 2N/3N
46.	P58.....	RV6200	6.2kW	220-240V 2/3 or 380-415V 2N/3N
47.	P58.....	RV6300	6.3kW	220-240V 2/3 or 380-415V 2N/3N
48.	P58.....	RV6400	6.4kW	220-240V 2/3 or 380-415V 2N/3N
49.	P58.....	RE5400	5.4kW	220-240V 2/3 or 380-415V 2N/3N
50.	P58.....	RE5500	5.5kW	220-240V 2/3 or 380-415V 2N/3N
51.	P58.....	RE5600	5.6kW	220-240V 2/3 or 380-415V 2N/3N
52.	P58.....	RE5700	5.7kW	220-240V 2/3 or 380-415V 2N/3N
53.	P58.....	RE5800	5.8kW	220-240V 2/3 or 380-415V 2N/3N
54.	P58.....	RE5900	5.9kW	220-240V 2/3 or 380-415V 2N/3N
55.	P58.....	RE6000	6.0kW	220-240V 2/3 or 380-415V 2N/3N

No.	Type	Model	Rated Power	Rated Voltage
56.	P58.....	RE6100	6.1kW	220-240V 2/3 or 380-415V 2N/3N
57.	P58.....	RE6200	6.2kW	220-240V 2/3 or 380-415V 2N/3N
58.	P58.....	RE6300	6.3kW	220-240V 2/3 or 380-415V 2N/3N
59.	P58.....	RE6400	6.4kW	220-240V 2/3 or 380-415V 2N/3N
60.	P58.....	RE6500	6.5kW	220-240V 2/3 or 380-415V 2N/3N
61.	P58.....	RE6600	6.6kW	220-240V 2/3 or 380-415V 2N/3N
62.	P58.....	RE6700	6.7kW	220-240V 2/3 or 380-415V 2N/3N
63.	P58.....	RE6800	6.8kW	220-240V 2/3 or 380-415V 2N/3N
64.	P58.....	RB5400	5.4kW	220-240V 2/3 or 380-415V 2N/3N
65.	P58.....	RB5500	5.5kW	220-240V 2/3 or 380-415V 2N/3N
66.	P58.....	RB5600	5.6kW	220-240V 2/3 or 380-415V 2N/3N
67.	P58.....	RB5700	5.7kW	220-240V 2/3 or 380-415V 2N/3N
68.	P58.....	RB5800	5.8kW	220-240V 2/3 or 380-415V 2N/3N
69.	P58.....	RB5900	5.9kW	220-240V 2/3 or 380-415V 2N/3N
70.	P58.....	RB6000	6.0kW	220-240V 2/3 or 380-415V 2N/3N
71.	P58.....	RB6100	6.1kW	220-240V 2/3 or 380-415V 2N/3N
72.	P58.....	RB6200	6.2kW	220-240V 2/3 or 380-415V 2N/3N
73.	P58.....	RB6300	6.3kW	220-240V 2/3 or 380-415V 2N/3N
74.	P58.....	RB6400	6.4kW	220-240V 2/3 or 380-415V 2N/3N
75.	P58.....	RB6500	6.5kW	220-240V 2/3 or 380-415V 2N/3N
76.	P58.....	RB6600	6.6kW	220-240V 2/3 or 380-415V 2N/3N
77.	P58.....	RB6700	6.7kW	220-240V 2/3 or 380-415V 2N/3N
78.	P58.....	RB6800	6.8kW	220-240V 2/3 or 380-415V 2N/3N
79.	P58.....	MO5400	5.4kW	220-240V 2/3 or 380-415V 2N/3N
80.	P58.....	MO5500	5.5kW	220-240V 2/3 or 380-415V 2N/3N
81.	P58.....	MO5600	5.6kW	220-240V 2/3 or 380-415V 2N/3N
82.	P58.....	MO5700	5.7kW	220-240V 2/3 or 380-415V 2N/3N
83.	P58.....	MO5800	5.8kW	220-240V 2/3 or 380-415V 2N/3N
84.	P58.....	MO5900	5.9kW	220-240V 2/3 or 380-415V 2N/3N
85.	P58.....	MO6000	6.0kW	220-240V 2/3 or 380-415V 2N/3N
86.	P58.....	MO6100	6.1kW	220-240V 2/3 or 380-415V 2N/3N
87.	P58.....	MO6200	6.2kW	220-240V 2/3 or 380-415V 2N/3N
88.	P58.....	MO6300	6.3kW	220-240V 2/3 or 380-415V 2N/3N

No.	Type	Model	Rated Power	Rated Voltage
89.	P58.....	MO6400	6.4kW	220-240V 2/3 or 380-415V 2N/3N
90.	P58.....	MV5400	5.4kW	220-240V 2/3 or 380-415V 2N/3N
91.	P58.....	MV5500	5.5kW	220-240V 2/3 or 380-415V 2N/3N
92.	P58.....	MV5600	5.6kW	220-240V 2/3 or 380-415V 2N/3N
93.	P58.....	MV5700	5.7kW	220-240V 2/3 or 380-415V 2N/3N
94.	P58.....	MV5800	5.8kW	220-240V 2/3 or 380-415V 2N/3N
95.	P58.....	MV5900	5.9kW	220-240V 2/3 or 380-415V 2N/3N
96.	P58.....	MV6000	6.0kW	220-240V 2/3 or 380-415V 2N/3N
97.	P58.....	MV6100	6.1kW	220-240V 2/3 or 380-415V 2N/3N
98.	P58.....	MV6200	6.2kW	220-240V 2/3 or 380-415V 2N/3N
99.	P58.....	MV6300	6.3kW	220-240V 2/3 or 380-415V 2N/3N
100.	P58.....	MV6400	6.4kW	220-240V 2/3 or 380-415V 2N/3N
101.	P58.....	ME5400	5.4kW	220-240V 2/3 or 380-415V 2N/3N
102.	P58.....	ME5500	5.5kW	220-240V 2/3 or 380-415V 2N/3N
103.	P58.....	ME5600	5.6kW	220-240V 2/3 or 380-415V 2N/3N
104.	P58.....	ME5700	5.7kW	220-240V 2/3 or 380-415V 2N/3N
105.	P58.....	ME5800	5.8kW	220-240V 2/3 or 380-415V 2N/3N
106.	P58.....	ME5900	5.9kW	220-240V 2/3 or 380-415V 2N/3N
107.	P58.....	ME6000	6.0kW	220-240V 2/3 or 380-415V 2N/3N
108.	P58.....	ME6100	6.1kW	220-240V 2/3 or 380-415V 2N/3N
109.	P58.....	ME6200	6.2kW	220-240V 2/3 or 380-415V 2N/3N
110.	P58.....	ME6300	6.3kW	220-240V 2/3 or 380-415V 2N/3N
111.	P58.....	ME6400	6.4kW	220-240V 2/3 or 380-415V 2N/3N
112.	P58.....	ME6500	6.5kW	220-240V 2/3 or 380-415V 2N/3N
113.	P58.....	ME6600	6.6kW	220-240V 2/3 or 380-415V 2N/3N
114.	P58.....	ME6700	6.7kW	220-240V 2/3 or 380-415V 2N/3N
115.	P58.....	ME6800	6.8kW	220-240V 2/3 or 380-415V 2N/3N
116.	P58.....	MB5400	5.4kW	220-240V 2/3 or 380-415V 2N/3N
117.	P58.....	MB5500	5.5kW	220-240V 2/3 or 380-415V 2N/3N
118.	P58.....	MB5600	5.6kW	220-240V 2/3 or 380-415V 2N/3N
119.	P58.....	MB5700	5.7kW	220-240V 2/3 or 380-415V 2N/3N
120.	P58.....	MB5800	5.8kW	220-240V 2/3 or 380-415V 2N/3N
121.	P58.....	MB5900	5.9kW	220-240V 2/3 or 380-415V 2N/3N

No.	Type	Model	Rated Power	Rated Voltage
122.	P58.....	MB6000	6.0kW	220-240V 2/3 or 380-415V 2N/3N
123.	P58.....	MB6100	6.1kW	220-240V 2/3 or 380-415V 2N/3N
124.	P58.....	MB6200	6.2kW	220-240V 2/3 or 380-415V 2N/3N
125.	P58.....	MB6300	6.3kW	220-240V 2/3 or 380-415V 2N/3N
126.	P58.....	MB6400	6.4kW	220-240V 2/3 or 380-415V 2N/3N
127.	P58.....	MB6500	6.5kW	220-240V 2/3 or 380-415V 2N/3N
128.	P58.....	MB6600	6.6kW	220-240V 2/3 or 380-415V 2N/3N
129.	P58.....	MB6700	6.7kW	220-240V 2/3 or 380-415V 2N/3N
130.	P58.....	MB6800	6.8kW	220-240V 2/3 or 380-415V 2N/3N
131.	P58.....	CO5800	5.8kW	220-240V 2/3 or 380-415V 2N/3N
132.	P58.....	CO6200	6.2kW	220-240V 2/3 or 380-415V 2N/3N
133.	P58.....	CV5800	5.8kW	220-240V 2/3 or 380-415V 2N/3N
134.	P58.....	CV6200	6.2kW	220-240V 2/3 or 380-415V 2N/3N
135.	P58.....	CE5800	5.8kW	220-240V 2/3 or 380-415V 2N/3N
136.	P58.....	CE6200	6.2kW	220-240V 2/3 or 380-415V 2N/3N
137.	P58.....	CB5800	5.8kW	220-240V 2/3 or 380-415V 2N/3N
138.	P58.....	CB6200	6.2kW	220-240V 2/3 or 380-415V 2N/3N
139.	P58.....	EO6800	6.8kW	220-240V 2/3 or 380-415V 2N/3N
140.	P58.....	EV6800	6.8kW	220-240V 2/3 or 380-415V 2N/3N
141.	P58.....	EO6700	6.7kW	220-240V 2/3 or 380-415V 2N/3N
142.	P58.....	EV6700	6.7kW	220-240V 2/3 or 380-415V 2N/3N
143.	P58.....	EO6600	6.6kW	220-240V 2/3 or 380-415V 2N/3N
144.	P58.....	EV6600	6.6kW	220-240V 2/3 or 380-415V 2N/3N
145.	P58.....	EO6500	6.5kW	220-240V 2/3 or 380-415V 2N/3N
146.	P58.....	EV6500	6.5kW	220-240V 2/3 or 380-415V 2N/3N
147.	P58.....	EC6000	6.0kW	220-240V 2/3 or 380-415V 2N/3N
148.	P58.....	EC6300 *)	6.3kW	220-240V 2/3 or 380-415V 2N/3N
149.	P58.....	EC6700 *)	6.7kW	220-240V 2/3 or 380-415V 2N/3N
150.	P58.....	EV6700	6.7kW	220-240V 2/3 or 380-415V 2N/3N
151.	P58.....	EC5400 *)	5.4kW	220-240V 2/3 or 380-415V 2N/3N
152.	P58.....	EC5500 *)	5.5kW	220-240V 2/3 or 380-415V 2N/3N
153.	P58.....	EO6400	6.4kW	220-240V 2/3 or 380-415V 2N/3N
No.	Type	Model	Rated Power	Rated Voltage

154	P58.....	EO6900	6.9kW	220-240V 2/3 or 380-415V 2N/3N
155	P58.....	EC6400	6.4kW	220-240V 2/3 or 380-415V 2N/3N

*) the recessed part possible to be normal dimension and slim dimension. See attachment - Comparison of normal dimension and slim dimension for detail.

Explanation of the Type reference:

P58=Piano (Built-in hobs), 58cm width
 The six dots are equal to the Model reference, see below

Explanation of the Model reference:

1.letter (type of command) = E (Electronic); R (energy Regulator);
 M (Mixed, commutators and energy regulators); C (Commutators = rotary switch)

2.letter (command position)= V (Vertical); O (Horizontal); E (External); B (Below); C (Horizontal Central)

The 4 next figures =Power Input (in Watts); From 5100 up to 6900, depending on the combination of hob elements.

The appliance fulfills the requirements of the relevant standards when installed as described in the instruction manual (see also clause 7.12.4):

The appliance possible equipped with additional optional fixing device for supplement the fixing of heating elements. See last 2 pages of photograph attachment for details.

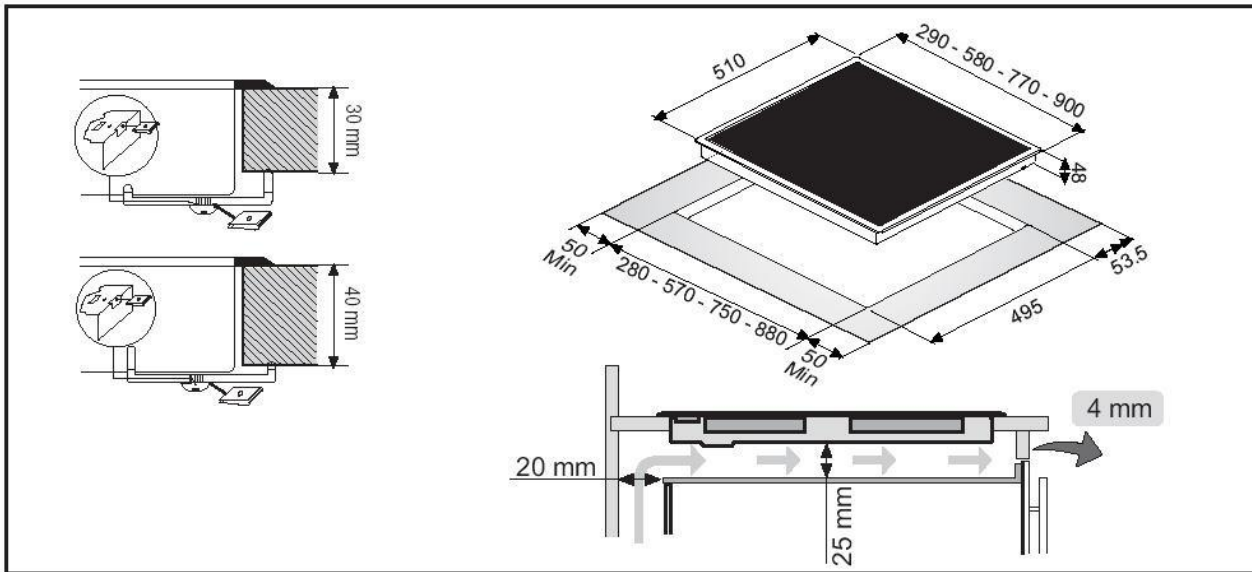

Dimensions in mm. (alternative slim dimension for some models. see model list in **General product information and attachment - Comparison of normal dimension and slim dimension for details**)

In order to identify elements, this scheme has to be considered when reading test results in the following sections.

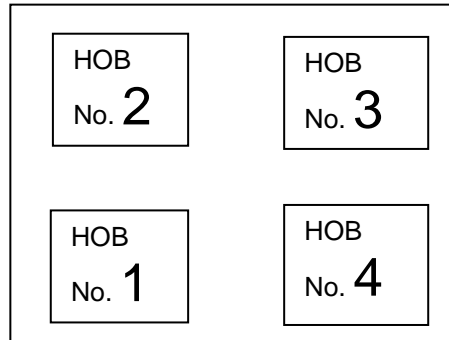

4 cooking positions

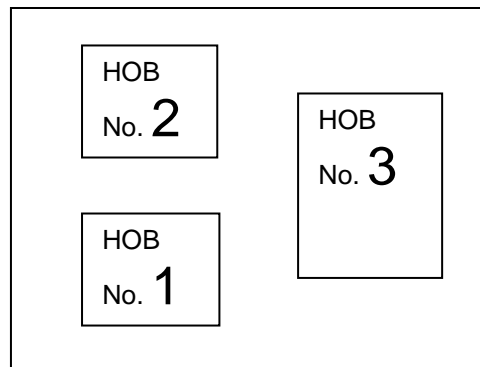

3 cooking positions

IEC 60335-2-6			
Clause	Requirement + Test	Result - Remark	Verdict
5	GENERAL CONDITIONS FOR THE TESTS		
	Tests performed according to cl. 5, e.g. nature of supply, sequence of testing, etc.		P
5.3	Addition: for pyrolytic self-cleaning ovens, the tests of 22.108 to 22.111 are carried out before the tests of Clause 19 (IEC 60335-2-6 : 2002)		N/A
5.4	Addition: appliances that also use gas are supplied with gas at the appropriate rated pressure. Vessels having a diameter of approximately 220mm are filled with 2 l of water, covered with a lid and placed on the hob burners. The controls are adjusted so that the water simmers, water being added when necessary to maintain the level (IEC 60335-2-6 : 2002)		N/A
5.101	Class III temperature-sensing probes are only subjected to the tests of Clause 19 (IEC 60335-2-6 : 2002)		N/A

6	CLASSIFICATION		
6.1	Protection against electric shock: Class I, II, III (IEC 60335-2-6 : 2002):	Class I	P
6.2	Protection against harmful ingress of water	IPX0	N/A

7	MARKING AND INSTRUCTIONS		
7.1	Rated voltage or voltage range (V)	220-240V 2/3~ 380-415V 2N/3N~	P
	Nature of supply	~	P
	Rated frequency (Hz)	50/60Hz	P
	Rated power input (W)	5,1kW to 6,9kW, see page 6-12 for details.	P
	Rated current (A)		N/A
	For induction hob elements and induction wok elements(IEC 60335-2-6 : 2002) total rated power input or rated current		N/A
	Manufacturer's or responsible vendor's name, trademark or identification mark		P
	Model or type reference	P58..... (see page 6-12 for model explanation)	P
	Symbol 5172 of IEC 60417, for Class II appliances		N/A
	IP number, other than IPX0		N/A

IEC 60335-2-6			
Clause	Requirement + Test	Result - Remark	Verdict
	Symbol IEC 60417-5036, for the enclosure of electrically-operated water valves in external hose-sets for connection of an appliance to the water mains		N/A
	Marking of the rated current of the fuse other than D-type fuse for cooking ranges incorporate a socket-outlet. (IEC 60335-2-6 : 2002)		N/A
	Marking of the rated current of the fuse other than D-type fuse (IEC 60335-2-6 : 2002)		N/A
7.2	Warning for stationary appliances for multiple supply		N/A
	Warning placed in vicinity of terminal cover		N/A
7.3	Range of rated values marked with the lower and upper limits separated by a hyphen	220-240V 380-415V	P
	Different rated values marked with the values separated by an oblique stroke	50/60Hz 2/3~ 2N/3N~	P
7.4	Appliances adjustable for different rated voltages, the voltage setting is clearly discernible		N/A
	Requirement met if frequent changes are not required and the rated voltage to which the appliance is to be adjusted is determined from a wiring diagram		N/A
7.5	Appliances with more than one rated voltage or one or more rated voltage ranges, marked with rated input or rated current for each rated voltage or range, unless		N/A
	the power input is related to the arithmetic mean value of the rated voltage range		P
	Relation between marking for upper and lower limits of rated power input or rated current and voltage is clear		N/A
7.6	Correct symbols used		P
	Symbol for nature of supply placed next to rated voltage		P
	Symbol for class II appliances placed unlikely to be confused with other marking		N/A
	Units of physical quantities and their symbols according to international standardized system		P
	Symbol IEC 60417-5010: ON/OFF (push-push) (IEC 60335-2-6 : 2002)		P
7.7	Connection diagram fixed to appliances to be connected to more than two supply conductors and appliances for multiple supply		N/A
	correct mode of connection is obvious		P
7.8	Except for type Z attachment, terminals for connection to the supply mains indicated as follows:		P

IEC 60335-2-6			
Clause	Requirement + Test	Result - Remark	Verdict
	- marking of terminals exclusively for the neutral conductor (letter N)		P
	- marking of protective earthing terminals (symbol IEC 60417-5019)		P
	- marking not placed on removable parts		P
7.9	Marking or placing of switches which may cause a hazard		P
7.10	Indications of switches on stationary appliances and controls on all appliances by use of figures, letters or other visual means	+, - and symbol for key, standard symbol for ON/OFF	P
	This applies also to switches which are part of a control		P
	If figures are used, the off position indicated by the figure 0		P
	The figure 0 indicates only OFF position, unless no confusion with the OFF position		P
	The figure 0 indicates OFF position and figure I indicates ON position of touch controls for hobs or (IEC 60335-2-6:2002)	For electronic touch control model	P
	for each hob element (IEC 60335-2-6:2002)		N/A
7.11	Indication for direction of adjustment of controls		P
7.12	Instructions for safe use provided		P
	Details concerning precautions during user maintenance		P
	The instructions state that:		-
	- the appliance is not to be used by persons (including children) with reduced physical, sensory or mental capabilities, or lack of experience and knowledge, unless they have been given supervision or instruction		P
	- children being supervised not to play with the appliance		P
	For a part of class III construction supplied from a detachable power supply unit, the instructions state that the appliance is only to be used with the unit provided		N/A
	Instructions for class III appliances state that it must only be supplied at SELV, unless		N/A
	it is a battery-operated appliance, the battery being charged outside the appliance		N/A
	Instructions shall include the following: (IEC 60335-2-6:2002)		-

IEC 60335-2-6			
Clause	Requirement + Test	Result - Remark	Verdict
	Warning: If the surface is cracked, switch off the appliance to avoid the possibility of electric shock, for hob surfaces of glass-ceramic or similar material which protect live parts		P
	During use the appliances becomes hot. Care should be taken to avoid touching heating elements inside the oven, for cooking ranges and ovens		N/A
	Instructions for ovens: (IEC 60335-2-6:2002)		-
	Warning: Accessible parts may become hot during use. Young children should be kept away.		N/A
	Instructions for ovens having doors with glass panels: (IEC 60335-2-6:2002)		-
	Do not use harsh abrasive cleaners or sharp metal scrapers to clean the oven door glass since they can scratch the surface, which may result in shattering of the glass.		N/A
	If during the test of Clause 11, the temperature rise at the centre of the internal bottom surface of a storage drawer exceeds that specified for handles held for short periods in normal use, the instruction shall state that these surfaces can get hot.		N/A
	Instructions for pyrolytic self-cleaning ovens shall: (IEC 60335-2-6:2002)		-
	- state that excess spillage must be remove before cleaning		N/A
	- specify which utensils can be left in the oven during cleaning		N/A
	Instructions shall state for cleaning used to set the controls to a position higher than for normal cooking purposes: (IEC 60335-2-6:2002)		-
	- that under such conditions the surfaces may be get hotter than usual		N/A
	- children should be kept away		N/A
	Instructions for ovens incorporating a fan with a guard that can removed for cleaning shall state that: (IEC 60335-2-6:2002)		-
	- the oven must be switched off before removing the guard and		N/A
	- after cleaning, the guard must be replaced in accordance with instructions		N/A
	Instructions for ovens provided with a facility to use a temperature-probe shall include the following: (IEC 60335-2-6:2002)		-
	-Only use the temperature probe recommended for this oven		N/A
	Instructions for cooking ranges, hobs and oven (IEC 60335-2-6:2002)		-
	-shall state a steam cleaner is not be used		P
	Instructions for induction hobs shall state the following: (IEC 60335-2-6:2002)		-
	-Metallic objects such as knives, forks, spoons and lids should not be placed on the hob surface since they can get hot		N/A
	Instructions for hobs incorporating a lid shall state (IEC 60335-2-6:2002)		-
	-Any spillage should be removed from the lid before opening. They also state than that		N/A

IEC 60335-2-6			
Clause	Requirement + Test	Result - Remark	Verdict
	- Hob surface should be allowed to cool before closing the lid		N/A
	Instructions for hobs incorporating halogen lamps shall warn the user not to stare at the hob elements (IEC 60335-2-6:2002)		-
	Instructions for hob incorporating a pan detector shall include the following (IEC 60335-2-6:2002)		-
	-After use, switch off the hob element by its control and do not rely on the pan detector		N/A
	Instructions for appliances incorporating a lamp for illumination, and does not incorporate a switch providing full disconnection under overvoltage category shall state the following: (IEC 60335-2-6:2002)		-
	-Warning - Ensure that the appliance is switched off before replacing the lamp to avoid the possibility of electric shock .		N/A
	The instructions for hobs shall state that the appliance is not intended to be operated by means of external timer or separated remote-control system (IEC 60335-2-6:2002)		P
	The instructions for hobs incorporating an induction wok element shall contain a list of vessels that can be used, unless the manufacturer provides a wok with the appliance (IEC 60335-2-6:2002)		N/A
	The instructions for ovens that have shelves shall include details indicating the correct installation of the shelves (IEC 60335-2-6:2002)		N/A
7.12.1	Sufficient details for installation supplied		P
	For an appliance intended to be permanently connected to the water mains and not connected by a hose-set, this is stated		N/A
	Instructions concerning cooking ranges placed on the floor. (60335-2-6: 2002)		N/A
	maximum rated pressure for appliance intended to be connected to the water supply. (60335-2-6: 2002)		N/A
7.12.2	Stationary appliances not fitted with means for disconnection from the supply mains having a contact separation in all poles that provide full disconnection under overvoltage category III, the instructions state that means for disconnection must be incorporated in the fixed wiring in accordance with the wiring rules		P
7.12.3	Insulation of the fixed wiring in contact with parts exceeding 50 K during clause 11; instructions stating that the fixed wiring must be protected		P
	Instructions for cooking range does not have a supply cord shall state the type of cord to be used, taking into account the temperature of the rear surface of the appliance (IEC 60335-2-6:2002)		N/A
7.12.4	Instructions for built-in appliances:		-
	- dimensions of space	580 * 510 mm	P

IEC 60335-2-6			
Clause	Requirement + Test	Result - Remark	Verdict
	- dimensions and position of supporting means		P
	- distances between parts and surrounding structure	Side: 50 mm Rear side: 53.5 mm Bottom side: 25 mm	P
	- dimensions of ventilation openings and arrangement		N/A
	- connection to supply mains and interconnection of separate components		P
	- allow disconnection of the appliance after installation, by accessible plug or a switch in the fixed wiring, unless	A switch in the fixed wiring	P
	a switch complying with 24.3		N/A
	Instructions for built-in appliances having a separate control panels shall state the control panel is only to be connected to heating units specified in order to avoid a possible hazard (IEC 60335-2-6:2002)	Only for models with E as the second letter	P
7.12.5	Replacement cord instructions, type X attachment with a specially prepared cord	Without special preparation	P
	Replacement cord instructions, type Y attachment		N/A
	Replacement cord instructions, type Z attachment		N/A
7.12.6	Caution in the instructions for heating appliances with a non-self-resetting thermal cut-out		N/A
7.12.7	Instructions for fixed appliances stating how the appliance is to be fixed		P
7.12.8	Instructions for appliances connected to the water mains:		-
	- max. inlet water pressure (Pa).....:		N/A
	- min. inlet water pressure, if necessary (Pa)		N/A
	Instructions concerning new and old hose-sets for appliances connected to the water mains by detachable hose-sets		N/A
7.13	Instructions and other texts in an official language	English version checked only. Manual will be provided in the official language of the countries that the appliances are to be sold.	P
7.14	Marking clearly legible and durable		P
7.15	Marking on a main part		P
	Marking clearly discernible from the outside, if necessary after removal of a cover		P
	For portable appliances, cover can be removed or opened without a tool		N/A

IEC 60335-2-6			
Clause	Requirement + Test	Result - Remark	Verdict
	For stationary appliances, name, trademark or identification mark and model or type reference visible after installation		N/A
	For fixed appliances, name, trademark or identification mark and model or type reference visible after installation according to the instructions		N/A
	Or included in the instruction of use (IEC 60335-2-6:2002)		P
	Or on an additional label fixed near the appliance after installation (IEC 60335-2-6:2002)		N/A
	Indications for switches and controls placed on or near the components. Marking not on parts which can be positioned or repositioned in such a way that the marking is misleading		P
	Marking for rated current of the fuse protecting a socket-outlet placed on or near the socket-outlet (IEC 60335-2-6:2002)		N/A
7.16	Marking of a possible replaceable thermal link or fuse link clearly visible with regard to replacing the link		N/A
7.101	Marking of the maximum water level, which shall be visible during filling, for steam generators intended to filled manually (IEC 60335-2-6:2002)		N/A
7.102	Appropriate marking the cooking zone of hob surfaces unless (IEC 60335-2-6:2002)		P
7.103	For cooking ranges that are normally placed on the floor and that have horizontally hinged oven doors with a hinge height of less than 430mm from the floor, if a stabilizing means is necessary in order to comply with the test of 20.102, then: (IEC 60335-2-6:2002)		N/A
	-The stabilizing means shall be marked, in lettering at least 3mm high, with the substance of the following warning: WARNING: in order to prevent tipping of the appliance, this stabilizing means must be installed. Refer to the instructions for installation.		N/A
	-The appliance shall be marked, in lettering at least 3mm high, at the point of supply entry and at least one other point to draw the attention of the user to the need to stabilize the appliance.		N/A
	it is obvious (IEC 60335-2-6:2002)		N/A

8	PROTECTION AGAINST ACCESS TO LIVE PARTS		
8.1	Adequate protection against accidental contact with live parts		P
8.1.1	Requirement applies for all positions, detachable parts removed		P

IEC 60335-2-6			
Clause	Requirement + Test	Result - Remark	Verdict
	Insertion or removal of lamps, protection against contact with live parts of the lamp cap		N/A
	Use of test probe B of IEC 61032: no contact with live parts		P
8.1.2	Use of test probe 13 of IEC 61032 through openings in class 0 appliances and class II appliances/ constructions: no contact with live parts		P
	Test probe 13 also applied through openings in earthed metal enclosures having a non-conductive coating: no contact with live parts		N/A
	Test probe 12 of IEC 61032 also applied to parts liable to be touched accidentally in normal use by a fork or similar pointed object: no contact with live parts (IEC 60335-2-6:2002)		P
8.1.3	For appliances other than class II, use of test probe 41 of IEC 61032: no contact with live parts of visible glowing heating elements		N/A
	Test probe 41: no contact with live parts of visible glowing heating elements situated at the top of the oven or grilling compartment. (IEC 60335-2-6:2002)		N/A
8.1.4	Accessible part not considered live if:		-
	- safety extra-low a.c. voltage: peak value not exceeding 42.4 V		N/A
	- safety extra-low d.c. voltage: not exceeding 42.4 V		N/A
	- or separated from live parts by protective impedance		N/A
	If protective impedance: d.c. current not exceeding 2 mA, and		N/A
	a.c. peak value not exceeding 0.7 mA		N/A
	- for peak values over 42.4 V up to and including 450 V, capacitance not exceeding 0,1 μF		N/A
	- for peak values over 450 V up to and including 15 kV, discharge not exceeding 45 μC		N/A
	- for peak values over 15kV, the energy in the discharge not exceeding 350 mJ		N/A
8.1.5	Live parts protected at least by basic insulation before installation or assembly:		-
	- built-in appliances		P
	- fixed appliances		N/A
	- appliances delivered in separate units		N/A
8.2	Class II appliances and constructions constructed so that there is adequate protection against accidental contact with basic insulation and metal parts separated from live parts by basic insulation only		P

IEC 60335-2-6			
Clause	Requirement + Test	Result - Remark	Verdict

	Only possible to touch parts separated from live parts by double or reinforced insulation		P
--	---	--	---

10	POWER INPUT AND CURRENT		
10.1	Power input at normal operating temperature, rated voltage and normal operation not deviating from rated power input by more than shown in table 1	(see appended table)	P
	Test carried out at upper and lower limits of the ranges for appliances with one or more rated voltage ranges, unless		N/A
	the rated power input is related to the arithmetic mean value		P
	Induction hob elements and induction wok elements: power input measured separately, tolerances for motor-appliances apply. (IEC 60335-2-6:2002)		N/A
	Socket-outlet are not loaded during the test (IEC 60335-2-6:2002)		N/A
10.2	Current at normal operating temperature, rated voltage and normal operation not deviating from rated current by more than shown in table 2	(see appended table)	N/A
	Test carried out at upper and lower limits of the ranges for appliances with one or more rated voltage ranges, unless		N/A
	the rated current is related to the arithmetic mean value of the range		N/A
	Induction hob elements and induction wok elements: current measured separately, tolerances for motor-appliances apply. (IEC 60335-2-6:2002)		N/A
	Socket-outlet are not loaded during the test (IEC 60335-2-6:2002)		N/A

11	HEATING		
11.1	No excessive temperatures in normal use		P
	For cooking ranges and ovens, compliance is also checked by the test of 11.101 (IEC 60335-2-6:2002)		N/A
11.2	Placing and mounting of appliance as described		P
	- built-in (IEC 60335-2-6:2002)	Acc. to installation instruction	P
	- against a wall (IEC 60335-2-6:2002)		N/A
	- on the floor (IEC 60335-2-6:2002)		N/A
	- fixed to the wall (IEC 60335-2-6:2002)		N/A
	- with or without the lid covering the hob surface (IEC 60335-2-6:2002)		N/A
	- temperature sensing probes: any position likely to occur during normal use. (IEC 60335-2-6:2002)		N/A

IEC 60335-2-6			
Clause	Requirement + Test	Result - Remark	Verdict
	- pyrolytic self-cleaning ovens: temperature sensing probe in position unless other instructions (IEC 60335-2-6:2002)		N/A
	Detachable parts that are intended to be used to reduce the temperature of controls panels are removed(IEC 60335-2-6:2002)		N/A
11.3	Temperature rises, other than of windings, determined by thermocouples		P
	Temperature rises of windings determined by resistance method, unless		P
	the windings makes it difficult to make the necessary connections		P
11.4	Heating appliances operated under normal operation at 1.15 times rated power input	$P = 1,15 * P_n * (240/230)^2$ (see table 11.8)	P
	Induction hob elements and induction wok elements supplied separately and operated as for motor operated appliances (IEC 60335-2-6:2002)		N/A
	Cooking ranges operated under normal operation at 1.15 times rated power input: (IEC 60335-2-6:2002)		N/A
11.5	Motor-operated appliances operated under normal operation at most unfavourable voltage between 0.94 and 1.06 times rated voltage.....		N/A
11.6	Combined appliances are operated as specified for heating appliances. (IEC 60335-2-6: 2002):		N/A
	If the temperature rise limits are exceeded in appliances incorporating motors, transformers or electronic circuits, and the power input is lower than the rated power input, the test is repeated with the appliance supplied at 1,06 times rated voltage . (IEC 60335-2-6: 2002)		N/A
11.7	Appliance operated for the duration specified in 11.7.101 to 11.7.106 (IEC 60335-2-6)		P
11.7.101	Induction hob elements and induction wok elements, other hob elements:	60 minutes	P
11.7.102	Ovens:		N/A
	Steam ovens operated in each mode of operation		N/A
	Lamps in ovens are not manually switched on		N/A
11.7.103	Grills		N/A
11.7.104	Griddles		N/A
11.7.105	Warming drawers and similar compartments:		N/A
11.7.106	Cooking ranges :		N/A
11.7.107	Appliance incorporates a socket-outlet with an appropriate plug complying with IEC60083		N/A
11.8	Temperature rises not exceeding values in table 3	(see appended tables)	P

IEC 60335-2-6			
Clause	Requirement + Test	Result - Remark	Verdict
	Temperatures rises of the floor and floor of the test corner, wooden cabinets and rectangular box not exceeding specified values (IEC 60335-2-6:2002)	- other appliances, 70K	P
	During the additional test for pyrolytic self-cleaning ovens, the temperature rise of the surface of knobs, handles and levers shall not exceed specified values (IEC 60335-2-6:2002)		P
	Sealing compound does not flow out		P
	Protective devices do not operate, except		P
	components in protective electronic circuits tested for the number of cycles specified in 24.1.4		N/A
11.101	Cooking ranges and ovens placed as described (IEC 60335-2-6:2002)		N/A
	Appliance operated under normal operation at rated voltage		N/A
	The appliance operated in specified conditions		N/A
	The appliance operated 60 min or		N/A
	until steady conditions are established		N/A
	Temperature rise of surfaces not exceed the values specified in Table 102 (IEC 60335-2-6:2002)	(see appended tables)	N/A

13	LEAKAGE CURRENT AND ELECTRIC STRENGTH AT OPERATING TEMPERATURE		
13.1	Leakage current not excessive and electric strength adequate		P
	Heating appliances operated at 1.15 times rated power input.....:	$P = 1,15 \times P_n \times (240/230)^2$ (see table 13.1)	P
	Motor-operated appliances and combined appliances supplied at 1.06 times rated voltage		N/A
	Protective impedance and radio interference filters disconnected before carrying out the tests		N/A
	If a grill is incorporated in the oven, either the oven or the grill is operated, whichever is more unfavourable. (IEC 60335-2-6:2002)		N/A
	For hobs, the tests are carried out with a vessel filled as specified in 3.1.9.101 placed on each cooking zone (IEC 60335-2-6:2002)		P
	Induction hob elements and induction wok elements are tested as specified for motor-operated appliances (IEC 60335-2-6:2002)		N/A
13.2	Leakage current measured by means of the circuit described in figure 4 of IEC 60990		P
	Leakage current measurements	(see appended table)	P
13.3	The appliance is disconnected from the supply		P
	Electric strength tests according to table 4	(see appended table)	P

IEC 60335-2-6			
Clause	Requirement + Test	Result - Remark	Verdict

	No breakdown during the tests		P
--	-------------------------------	--	---

14	TRANSIENT OVERVOLTAGES		
	Appliances withstand the transient overvoltages to which they may be subjected		N/A
	Clearances having a value less than specified in table 16 subjected to an impulse voltage test, the test voltage specified in table 6	(see appended table)	N/A
	No flashover during the test, unless of functional insulation		N/A
	In case of flashover of functional insulation, the appliance complies with clause 19 with the clearance short circuited		N/A

15	MOISTURE RESISTANCE		
15.1	Enclosure provides the degree of moisture protection according to classification of the appliance		N/A
	Compliance checked as specified in 15.1.1, taking into account 15.1.2, followed by the electric strength test of 16.3		N/A
	No trace of water on insulation which can result in a reduction of clearances and creepage distances below values specified in clause 29		N/A
15.1.1	Appliances, other than IPX0, subjected to tests as specified in IEC 60529		N/A
	Water valves in external hoses for connection of an appliance to the water mains tested as specified for IPX7 appliances		N/A
15.1.2	Hand-held appliance turned continuously through the most unfavourable positions during the test		N/A
	Built-in appliances installed according to the instructions		N/A
	Appliances placed or used on the floor or table placed on a horizontal unperforated support		N/A
	Appliances normally fixed to a wall and appliances with pins for insertion into socket-outlets are mounted on a wooden board		N/A
	For IPX3 appliances, the base of wall mounted appliances is placed at the same level as the pivot axis of the oscillating tube		N/A

IEC 60335-2-6			
Clause	Requirement + Test	Result - Remark	Verdict
	For IPX4 appliances, the horizontal centre line of the appliance is aligned with the pivot axis of the oscillating tube		N/A
	However, for appliances normally used on the floor or table, the movement is limited to two times 90° for a period of 5 min, the support being placed at the level of the pivot axis of the oscillating tube		N/A
	Appliances normally fixed to a ceiling are mounted underneath a horizontal unperforated support, the pivot axis of the oscillating tube located at the level of the underside of the support		N/A
	For IPX4 appliances, the movement of the tube is limited to two times 90° from the vertical for a period of 5 min		N/A
	Wall-mounted appliances, take into account the distance to the floor stated in the instructions		N/A
	Appliances with type X attachment fitted with a flexible cord as described		N/A
	Detachable parts tested as specified		N/A
15.2	Spillage of liquid does not affect the electrical insulation		P
	Appliances incorporating an appliance inlet tested with or without an connector, whichever is most unfavourable		N/A
	Detachable parts removed		N/A
	Overfilling test with additional amount of water, over a period of 1 min, quantity (l) :		-
	Cooking ranges and hobs subjected to the overfilling test into the vessel with additional saline solution, over a period of 15 s (l)..... : (IEC 60335-2-6:2002)	0.5 l	P
	For hob elements incorporating a switch or a thermal control: overfilling test with saline solution(l): (IEC 60335-2-6:2002)..... :		N/A
	If controls are mounted below the hob surface: overfilling test with saline solution, over a period of 15 s (l)..... : (IEC 60335-2-6:2002)		N/A
	If controls are mounted in the hob surface: overfilling test with saline solution, over them (l) : (IEC 60335-2-6:2002)	0.5 l	P
	For hob having ventilating openings in the hob surface: overfilling test with saline solution (l) : (IEC 60335-2-6:2002)		N/A
	For ovens and grills: overfilling test with saline solution (l) : (IEC 60335-2-6:2002)		N/A

IEC 60335-2-6			
Clause	Requirement + Test	Result - Remark	Verdict
	For appliances having a drip tray or similar receptacle: overfilling test with saline solution (I) ... : (IEC 60335-2-6:2002)		N/A
	For hobs having a lid: overfilling test with saline solution (I) : (IEC 60335-2-6:2002)		N/A
	Test repeated: overfilling test with saline solution , over a period of 15 s (I)..... : (IEC 60335-2-6:2002)		N/A
	Steam generators intended to be connected to the water mains supplied at rated water pressure (IEC 60335-2-6:2002)		N/A
	Water allowed to flow for 1 min after the first evidence of overflow, unless (IEC 60335-2-6:2002)		N/A
	the inflow stops automatically (IEC 60335-2-6:2002)		N/A
	The appliance withstands the electric strength test of 16.3		P
	No trace of water on insulation that can result in a reduction of clearances and creepage distances below values specified in clause 29		P
15.3	Appliances proof against humid conditions		P
	Checked by test Cab: Damp heat steady state in IEC 60068-2-78		P
	Humidity test for 48 h in a humidity cabinet		P
	Reassembly of those parts that may have been removed		N/A
	The appliance withstands the tests of clause 16		P
15.101	Temperature-sensing probes shall be constructed so that their insulation is not affected by water (IEC 60335-2-6:2002)		N/A
	After the test, the probe withstand the leakage current test of 16.2 (IEC 60335-2-6:2002)		N/A

16	LEAKAGE CURRENT AND ELECTRIC STRENGTH		
16.1	Leakage current not excessive and electric strength adequate		P
	Protective impedance disconnected from live parts before carrying out the tests		N/A
	Induction hob elements and induction wok elements: tested as motor-operated appliances (60335-2-6)		N/A
16.2	Single-phase appliances: test voltage 1.06 times rated voltage	1,06 x 240V = 254,4V	P
	Three-phase appliances: test voltage 1.06 times rated voltage divided by $\sqrt{3}$	1,06 x 415V / $\sqrt{3}$ = 254V	P

IEC 60335-2-6			
Clause	Requirement + Test	Result - Remark	Verdict
	Leakage current measurements	(see appended table)	P
16.3	Electric strength tests according to table 7	(see appended table)	P
	No breakdown during the tests		P

17	OVERLOAD PROTECTION OF TRANSFORMERS AND ASSOCIATED CIRCUITS		
	No excessive temperatures in transformer or associated circuits in event of short-circuits likely to occur in normal use	(see appended table)	N/A
	Appliance supplied with 1.06 or 0.94 times rated voltage and the most unfavourable short-circuit or overload likely to occur in normal use applied		N/A
	Temperature rise of insulation of the conductors of safety extra-low voltage circuits not exceeding the relevant value specified in table 3 by more than 15 K		N/A
	Temperature of the winding not exceeding the value specified in table 8,		N/A
	however limits do not apply to fail-safe transformers complying with sub-clause 15.5 of IEC 61558-1		N/A

19	ABNORMAL OPERATION		
19.1	The risk of fire or mechanical damage under abnormal or careless operation obviated		P
	Electronic circuits so designed and applied that a fault will not render the appliance unsafe	Only for models with E as the first letter	P
	Appliances incorporating heating elements subjected to the tests of 19.2 and 19.3, and		P
	if the appliance also has a control that limit the temperature during clause 11 it is subjected to the test of 19.4, and		P
	if applicable, to the test of 19.5		N/A
	Appliances incorporating PTC heating elements are also subjected to the test of 19.6		N/A
	Appliances incorporating motors subjected to the tests of 19.7 to 19.10, as applicable		N/A
	Appliances incorporating electronic circuits subjected to the tests of 19.11 and 19.12, as applicable		P
	Appliances incorporating contactors or relays subjected to the test of 19.14, being carried out before the tests of 19.11		P
	Appliances incorporating voltage selector switches subjected to the test of 19.15		N/A

IEC 60335-2-6			
Clause	Requirement + Test	Result - Remark	Verdict
	Unless otherwise specified, the tests are continued until a non-self-resetting thermal cut-out operates, or		P
	until steady conditions are established		P
	For induction hobs compliance is also checked by the test 19.101 and 19.102 (19.4 not applicable) (IEC 60335-2-6:2002)		N/A
	19.101 is not applicable to induction wok elements (IEC 60335-2-6:2002)		N/A
	Temperature-sensing probes placed in the oven in any position likely to occur during normal use that they are connected to control the oven temperature (IEC 60335-2-6:2002)		N/A
19.2	Test of appliance with heating elements with restricted heat dissipation; test voltage (V): power input of 0.85 times rated power input	$P = 0,85 \times P_n \times (220/230)^2$ see appended table	P
	Hob elements are operated without a vessel, pan detectors being rendered inoperative. Oven doors are open or closed, whichever is more unfavourable. Hob lids are closed unless the hob elements are interlocked with the lid or an indicator lamp shows that a hob element is switched on. (IEC 60335-2-6:2002)		P
	For appliances incorporating more than one heating unit, the test is only carried with the heating unit resulting in the most unfavourable conditions, its control adjusted to the highest setting. For appliance incorporate an oven without an indicator lamp to show that the oven is switched on, the oven is operated, its control adjusted to the highest setting. (IEC 60335-2-6:2002)		P
	For induction hob element or induction wok element with a metallic lid: a force of 30N is applied to the closed lid in the most unfavourable place by means of test probe B of IEC 61032. (IEC 60335-2-6:2002)		N/A
	Pyrolytic self-cleaning ovens are also operated under cleaning conditions, motors which operate during cleaning being switched off or disconnect in turn. (IEC 60335-2-6:2002)		N/A
	Induction hob elements and induction wok elements are operated under the conditions of clause 11 but with empty vessels, the controls being adjusted to the highest setting. (IEC 60335-2-6:2002)		N/A
	Steam ovens are operated without water (IEC 60335-2-6:2002)		N/A
	Doors of separate grill compartments incorporate a cooking range are open or closed, which is the most unfavourable. (IEC 60335-2-6:2002)		N/A

IEC 60335-2-6			
Clause	Requirement + Test	Result - Remark	Verdict
19.3	Test of 19.2 repeated; test voltage (V): power input of 1.24 times rated power input.....	$P = 1,24 \times P_n \times (240/230)^2$ see appended table	P
19.4	Test conditions as in cl. 11, any control limiting the temperature during tests of cl. 11 short-circuited		P
19.5	Test of 19.4 repeated on Class 0I and I appliances with tubular sheathed or embedded heating elements. No short-circuiting, but one end of the element connected to the elements sheath		N/A
	The test repeated with reversed polarity and the other end of the heating element connected to the sheath		N/A
	The test is not carried out on appliances intended to be permanently connected to fixed wiring and on appliances where an all-pole disconnection occurs during the test of 19.4		N/A
19.6	Appliances with PTC heating elements tested at rated voltage, establishing steady conditions		N/A
	The working voltage of the PTC heating element is increased by 5% and the appliance is operated until steady conditions are re-established. The voltage is then increased in similar steps until 1.5 times working voltage or until the PTC heating element ruptures		N/A
19.7	Stalling test by locking the rotor if the locked rotor torque is smaller than the full load torque or locking moving parts of other appliances		N/A
	Locked rotor, motor capacitors open-circuited or short-circuited, if required		N/A
	Locked rotor, capacitors open-circuited one at a time		N/A
	Test repeated with capacitors short-circuited one at a time, unless		N/A
	capacitor is of class P2 of IEC 60252-1		N/A
	Appliances with timer or programmer supplied with rated voltage for each of the tests, for a period equal to the maximum period allowed		N/A
	Other appliances supplied with rated voltage for a period as specified		N/A
	Winding temperatures not exceeding values specified in table 8	(see appended table)	N/A
19.8	Three-phase motors operated at rated voltage with one phase disconnected		N/A
19.10	Series motor operated at 1.3 times rated voltage for 1 min.....		N/A
	During the test, parts not being ejected from the appliance		N/A

IEC 60335-2-6			
Clause	Requirement + Test	Result - Remark	Verdict
19.11	Electronic circuits, compliance checked by evaluation of the fault conditions specified in 19.11.2 for all circuits or parts of circuits, unless they comply with the conditions specified in 19.11.1		P
	Appliances incorporating a protective electronic circuit subjected to the tests of 19.11.3 and 19.11.4		N/A
	Appliances incorporating an electronic circuit that relies upon a programmable component to function correctly, subjected to the test of 19.11.4.8, unless	In case of restart the appliance rests in locked position. At least two manual operations are necessary to restart.	P
	restarting does not result in a hazard		N/A
	Appliances having a device with an off position obtained by electronic disconnection, or a device placing the appliance in a stand-by mode, subjected to the tests of 19.11.4		P
	If the safety of the appliance under any of the fault conditions depends on the operation of a miniature fuse-link complying with IEC 60127, the test of 19.12 is carried out		N/A
	During and after each test the following is checked:		-
	- the temperature of the windings do not exceed the values specified in table 8		P
	- the appliance complies with the conditions specified in 19.13		P
	- any current flowing through protective impedance not exceeding the limits specified in 8.1.4		N/A
	If a conductor of a printed board becomes open-circuited, the appliance is considered to have withstood the particular test, provided both of the following conditions are met:		N/A
	- the base material of the printed circuit board withstands the test of Annex E		N/A
	- any loosened conductor does not reduce clearance or creepage distances between live parts and accessible metal parts below the values specified in clause 29		N/A
19.11.1	Before applying the fault conditions a) to f) in 19.11.2, it is checked if circuits or parts of circuit meet both of the following conditions:		-
	- the electronic circuit is a low-power circuit, that is, the maximum power at low-power points does not exceed 15 W according to the tests specified		N/A

IEC 60335-2-6			
Clause	Requirement + Test	Result - Remark	Verdict
	- the protection against electric shock, fire hazard, mechanical hazard or dangerous malfunction in other parts of the appliance does not rely on the correct functioning of the electronic circuit		N/A
19.11.2	Fault conditions applied one at a time, the appliance operated under conditions specified in cl. 11, but supplied at rated voltage, the duration of the tests as specified:		-
	a) short circuit of functional insulation if clearances or creepage distances are less than the values specified in 29		N/A
	b) open circuit at the terminals of any component		P
	c) short circuit of capacitors, unless they comply with IEC 60384-14		P
	d) short circuit of any two terminals of an electronic component, other than integrated circuits. This fault condition is not applied between the two circuits of an optocoupler		P
	e) failure of triacs in the diode mode		N/A
	f) failure of an integrated circuit		N/A
	g) failure of an electronic power switching device		N/A
	Each low power circuit is short-circuited by connecting the low-power point to the pole of the supply source from which the measurements were made		N/A
	During simulation it shall possible to switch of any energized hob element (IEC 60335-2-6:2002)		P
	The hob elements shall not become energized (IEC 60335-2-6:2002)		P
19.11.3	If the appliance incorporates a protective electronic circuit which operates to ensure compliance with clause 19, the relevant test is repeated with a single fault simulated, as indicated in a) to g) of 19.11.2		N/A
19.11.4	Appliances having a device with an off position obtained by electronic disconnection, or		P
	a device that can be placed in the stand-by mode,		P
	subjected to the tests of 19.11.4.1 to 19.11.4.7		P
	Appliances incorporating a protective electronic circuit subjected to the tests of 19.11.4.1 to 19.11.4.7, except that		N/A
	appliances operated for 30 s or 5 min during the test of 19.7 are not subjected to the tests for electromagnetic phenomena.		N/A
	Surge protective devices disconnected, unless		N/A
	They incorporate spark gaps		N/A

IEC 60335-2-6			
Clause	Requirement + Test	Result - Remark	Verdict
	During the test of the stand-by-mode, a suitable vessel is placed on the cooking zone if a pan detector is incorporate. (IEC 60335-2-6:2002)		N/A
19.11.4.1	The appliance is subjected to electrostatic discharges in accordance with IEC 61000-4-2, test level 4		P
19.11.4.2	The appliance is subjected to radiated fields in accordance with IEC 61000-4-3, test level 3		P
19.11.4.3	The appliance is subjected to fast transient bursts in accordance with IEC 61000-4-4, test level 3 or 4 as specified		P
19.11.4.4	The power supply terminals of the appliance subjected to voltage surges in accordance with IEC 61000-4-5, test level 3 or 4 as specified		P
	Earthed heating elements in class I appliances disconnected		P
19.11.4.5	The appliance is subjected to injected currents in accordance with IEC 61000-4-6, test level 3		P
19.11.4.6	The appliance is subjected to the Class 3 voltage dips and interruptions in accordance with IEC 61000-4-11		P
19.11.4.7	The appliance is subjected to mains signals in accordance with IEC 61000-4-13, test level class 2		P
19.11.4.8	The appliance is supplied at rated voltage and operated under normal operation. After 60s the power supply is reduces to a level such that the appliance ceases to respond or a programmable component cease to operate.		P
	The appliance continues to operate normally or requires a manual operation to restart		P
19.12	If the safety of the appliance for any of the fault conditions specified in 19.11.2 depends on the operation of a miniature fuse-link complying with IEC 60127, the test is repeated, measuring the current flowing through the fuse-link; measured current (A); rated current of the fuse-link (A).....:		N/A
19.13	During the tests the appliance does not emit flames, molten metal, poisonous or ignitable gas in hazardous amounts		P
	Temperature rises not exceeding the values shown in table 9	(see appended table)	P
	Enclosures not deformed to such an extent that compliance with cl. 8 is impaired		P
	If the appliance can still be operated it complies with 20.2		P

IEC 60335-2-6			
Clause	Requirement + Test	Result - Remark	Verdict
	Insulation, other than of class III appliance, withstand the electric strength test of 16.3, the test voltage specified in table 4:		-
	- basic insulation.....: :	1000V	P
	- supplementary insulation: :		N/A
	- reinforced insulation.....: :	3000V	P
	After operation or interruption of a control, clearances and creepage distances across the functional insulation withstanding the electric strength test of 16.3. the test voltage being twice the working voltage		P
	The appliance does not undergo a dangerous malfunction, and		P
	no failure of protective electronic circuits, if the appliance is still operable		N/A
	Appliances tested with an electronic switch in the off position, or in the stand-by mode:		-
	- do not become operational, or		P
	- if they become operational, do not result in a dangerous malfunction during or after the tests of 19.11.4		P
	If the appliance contains lids or doors that are controlled by one or more interlocks, one of the interlocks may be released provided that:		-
	- the lid or door does not move automatically to an open position when the interlock is released, and		N/A
	- the appliance does not start after the cycle in which the interlock was released		N/A
	Ovens: temperature in the centre of the oven not exceed 425°C before opening (IEC 60335-2-6:2002)		N/A
	Temperature rise of the windings of induction hob elements and induction wok elements not exceed the values specified in 19.7 (IEC 60335-2-6:2002)		N/A
	Electric strength test of induction hob elements and induction wok elements is carried out immediately after switching of the appliance (IEC 60335-2-6:2002)		N/A
	Glass in oven doors shall not be damaged (60335-2-6)		N/A
19.14	Appliances operated under the conditions of Clause 11. Contactors or relays contacts operating under the conditions of clause 11 short-circuited	Thermostats integrated in the heating elements operated	P
19.15	For appliances with a mains voltage selector switch, the switch is set to the lowest rated voltage position and the highest value of rated voltage is applied		N/A

IEC 60335-2-6			
Clause	Requirement + Test	Result - Remark	Verdict
19.101	Induction hob elements: test conditions according to the standard; diameter of the disc (cm) (IEC 60335-2-6)		N/A
19.102	Induction hob element and induction wok elements operated under normal operation at rated voltage but with thermal controls short-circuited. (IEC 60335-2-6:2002)		N/A
	Temperature rise of the oil not exceed 270 K: (IEC 60335-2-6:2002)		N/A

20	STABILITY AND MECHANICAL HAZARDS		
20.1	Adequate stability	Built-in appliance	N/A
	Tilting test through an angle of 10° (appliance placed on an inclined plane/horizontal plane); appliance does not overturn		N/A
	Tilting test repeated on appliances with heating elements, angle of inclination increased to 15°		N/A
	Possible heating test in overturned position; temperature rise does not exceed values shown in table 9		N/A
20.2	Moving parts adequately arranged or enclosed as to provide protection against personal injury	No moving part	N/A
	Protective enclosures, guards and similar parts are non-detachable		N/A
	Adequate mechanical strength and fixing of protective enclosures		N/A
	Self-resetting thermal cut-outs and overcurrent protective devices not causing a hazard, by unexpected reclosure		N/A
	Not possible to touch dangerous moving parts with test probe		N/A
20.101	Cooking range and ovens shall have adequate stability when the open the door is subjected to a load (IEC 60335-2-6:2002)		-
	Appliance subjected to a load test and by the test of 20.102 if relevant : mass (kg) :		N/A
	Cooking ranges are tested without fitting any stabilizing means that are specified in the instructions of installation.		N/A
	Cooking range incorporating a storage compartment adjacent to the oven and which the shelves are pulled out simultaneously: Shelf subjected to a load test : mass (g)		N/A
	The appliance shall not tilt Damage and deformation of doors are ignored		N/A

IEC 60335-2-6			
Clause	Requirement + Test	Result - Remark	Verdict
20.102	For cooking ranges normally placed on the floor and with horizontally hinged oven doors with a hinge height of less than 430mm from the floor, the test of 20.101 is repeated except that: (IEC 60335-2-6:2002)		-
	-The cooking range is fitted with the stabilizing means, if any, specified in the instructions for installation		N/A
	-The mass of the load on the oven doors is increased to 50kg, or the mass of 22,5kg is placed at the centre of the outer edge of the oven door, whichever gives the most unfavourable results		N/A
	The appliance shall not tilt Damage and deformation of doors are ignored		N/A

21	MECHANICAL STRENGTH		
21.1	Appliance has adequate mechanical strength and is constructed as to withstand rough handling		P
	Checked by applying blows to the appliance in accordance with test Ehb of IEC 60068-2-75, spring hammer test, impact energy 0,5 J		P
	If necessary, supplementary or reinforced insulation subjected to the electric strength test of 16.3		N/A
	If necessary, repetition of groups of three blows on a new sample		N/A
	Additional blows applied to the centre of glass doors (IEC 60335-2-6:2002)		N/A
	The glass shall not fracture (IEC 60335-2-6:2002)		N/A
	Appliance incorporating visibly glowing heating elements enclosed in glass tubes, the blows are applied to the tubes as mounted in the appliance if they are : (IEC 60335-2-6:2002)		-
	-located at the top of the oven and accessible to test probe 41 of IEC 61032		N/A
	-located elsewhere in the oven and accessible to test probe B of IEC 61032		N/A
	Hob surfaces of glass-ceramic or similar material: three blows applied on surfaces not exposed during test of 21.102; impact energy $0,7 \pm 0,05$ J (IEC 60335-2-6:2002)		P
	Temperature-sensing probe subjected to one cycle of test according to 15.101 and 16.2 (IEC 60335-2-6:2002)		N/A
21.2	Accessible parts of solid insulation having strength to prevent penetration by sharp implements	Cover of supply terminal	P
	The insulation is tested as specified, unless		N/A
	the thickness of supplementary insulation is at least 1 mm and reinforced insulation is at least 2 mm		P

IEC 60335-2-6			
Clause	Requirement + Test	Result - Remark	Verdict
21.101	Oven shelves and their supports shall have adequate mechanical strength (IEC 60335-2-6:2002)		N/A
	Total mass (kg) of the vessel, 220 times the volume of the useful oven space in m ³ , or 24kg, whichever is less:		N/A
	After the test the shelf and supports shall show no distortion impairing their further and		N/A
	the shelf shall not fall from the supports		N/A
	Ovens with shelves that can be withdrawn and with stops: force of 80N, vessel with side dimensions 200mm		N/A
	The shelf shall not tilt downwards by more than 6°		N/A
21.102	Hob surfaces of glass-ceramic and similar materials shall withstand the stresses liable to occur in normal use (IEC 60335-2-6:2002)		P
	After the test, the hob surface not crack and the appliance withstand the electric strength test of 16.3		P
21.103	Temperature-sensing probes shall be constructed so that they are not damaged when trapped in the oven door (IEC 60335-2-6:2002)		N/A
	After the test, the probe then complies with 8.1, 15.101 and Cl. 29		N/A
21.104	Glass panels of horizontally hinged oven doors shall withstand the thermal shock liable to occur in normal use (IEC 60335-2-6:2002)		N/A
	After the test, the glass shall not fracture		N/A

22	CONSTRUCTION		
22.1	Appliance marked with the first numeral of the IP system, relevant requirements of IEC 60529 are fulfilled		N/A
22.2	Stationary appliance: means to provide all-pole disconnection from the supply provided, the following means being available:		-
	- a supply cord fitted with a plug		N/A
	- a switch complying with 24.3		N/A
	- a statement in the instruction sheet that a disconnection incorporated in the fixed wiring is to be provided		P
	- an appliance inlet		N/A
	Single-pole switches and single-pole protective devices for the disconnection of heating elements in single-phase, permanently connected class 01 and class I appliances, connected to the phase conductor		N/A
22.3	Appliance provided with pins: no undue strain on socket-outlets		N/A

IEC 60335-2-6			
Clause	Requirement + Test	Result - Remark	Verdict
	Applied torque not exceeding 0.25 Nm		N/A
	Pull force of 50N to each pin after the appliance has been placed in the heating cabinet; when cooled to room temperature the pins are not displaced by more than 1mm		N/A
	Each pin subjected to a torque of 0.4Nm; the pins are not rotating unless rotating does not impair compliance with the standard		N/A
22.4	Appliance for heating liquids and appliance causing undue vibration not provided with pins for insertion into socket-outlets	Built-in hobs	N/A
22.5	No risk of electric shock when touching the pins of the plug, for appliances having a capacitor with rated capacitance exceeding 0,1µF, the appliance being disconnected from the supply at the instant of voltage peak	100nF only	N/A
22.6	Electrical insulation not affected by condensing water or leaking liquid		P
	Electrical insulation of Class II appliances not affected in case of a hose rupture or seal leak		N/A
22.7	Adequate safeguards against the risk of excessive pressure in appliances provided with steam-producing devices		N/A
22.8	Electrical connections not subject to pulling during cleaning of compartments to which access can be gained without the aid of a tool, and that are likely to be cleaned in normal use		P
22.9	Insulation, internal wiring, windings, commutators and slip rings not exposed to oil, grease or similar substances		P
	Adequate insulating properties of oil or grease to which insulation is exposed		N/A
22.10	Not possible to reset voltage-maintained non-self-resetting thermal cut-outs by the operation of an automatic switching device incorporated within the appliance		N/A
	Non-self-resetting thermal motor protectors have a trip-free action, unless		N/A
	they are voltage maintained		N/A
	Location or protection of reset buttons of non-self-resetting controls is so that accidental resetting is unlikely		N/A
22.11	Reliable fixing of non-detachable parts that provide the necessary degree of protection against electric shock, moisture or contact with moving parts		P

IEC 60335-2-6			
Clause	Requirement + Test	Result - Remark	Verdict
	Obvious locked position of snap-in devices used for fixing such parts		P
	No deterioration of the fixing properties of snap-in devices used in parts that are likely to be removed during installation or servicing		P
	Tests as described		P
22.12	Handles, knobs etc. fixed in a reliable manner		P
	Fixing in wrong position of handles, knobs etc. indicating position of switches or similar components not possible		P
	Axial force 15 N applied to parts, the shape being so that an axial pull is unlikely to be applied	For all model except with E (electronic touch control)	P
	Axial force 30 N applied to parts, the shape being so that an axial pull is likely to be applied		N/A
22.13	Unlikely that handles, when gripped as in normal use, make the operators hand touch parts having a temperature rise exceeding the value specified for handles which are held for short periods only		N/A
22.14	No ragged or sharp edges creating a hazard for the user in normal use, or during user maintenance		P
	No exposed pointed ends of self-tapping screws etc., liable to be touched by the user in normal use or during user maintenance		P
22.15	Storage hooks and the like for flexible cords smooth and well rounded		N/A
22.16	Automatic cord reels cause no undue abrasion or damage to the sheath of the flexible cord, no breakage of conductors strands, no undue wear of contacts		N/A
	Cord reel tested with 6000 operations, as specified		N/A
	Electric strength test of 16.3, voltage of 1000 V applied		N/A
22.17	Spacers not removable from the outside by hand or by means of a screwdriver or a spanner		N/A
22.18	Current-carrying parts and other metal parts resistant to corrosion under normal conditions of use		P
22.19	Driving belts not used as electrical insulation		N/A
22.20	Direct contact between live parts and thermal insulation effectively prevented, unless material used is non-corrosive, non-hygroscopic and non-combustible		P
	Compliance is checked by inspection and, if necessary, by appropriate test		N/A

IEC 60335-2-6			
Clause	Requirement + Test	Result - Remark	Verdict
22.21	Wood, cotton, silk, ordinary paper and fibrous or hygroscopic material not used as insulation, unless impregnated	Such material not used	N/A
	Magnesium oxide and mineral ceramic fibres are not considered as hygroscopic materials (60335-2-6)		N/A
22.22	Appliances not containing asbestos		P
22.23	Oils containing polychlorinated biphenyl (PCB) not used		P
22.24	Bare heating elements adequately supported		P
	In case of rupture, the heating conductor is unlikely to come in contact with accessible metal parts		P
22.25	Sagging heating conductors cannot come into contact with accessible metal parts		N/A
22.26	The insulation between parts operating at safety extra-low voltage and other live parts complies with the requirements for double or reinforced insulation		N/A
22.27	Parts connected by protective impedance separated by double or reinforced insulation		N/A
22.28	Metal parts of Class II appliances conductively connected to gas pipes or in contact with water: separated from live parts by double or reinforced insulation		N/A
22.29	Class II appliances permanently connected to fixed wiring so constructed that the required degree of access to live parts is maintained after installation		N/A
22.30	Parts serving as supplementary or reinforced insulation fixed so that they cannot be removed without being seriously damaged, or		P
	so constructed that they cannot be replaced in an incorrect position, and so that if they are omitted, the appliance is rendered inoperable or manifestly incomplete		N/A
22.31	Clearances and creepage distances over supplementary and reinforced insulation not reduced below values specified in clause 29 as a result of wear		P
	Clearances and creepage distances between live parts and accessible parts not reduced below values for supplementary insulation, if wires, screws etc. become loose		P
22.32	Supplementary and reinforced insulation designed or protected against deposition of dirt or dust		P

IEC 60335-2-6			
Clause	Requirement + Test	Result - Remark	Verdict
	Supplementary insulation of natural or synthetic rubber resistant to ageing, or arranged and dimensioned so that creepage distances are not reduced below values specified in 29.2		N/A
	Ceramic material not tightly sintered, similar material or beads alone not used as supplementary or reinforced insulation		N/A
	Oxygen bomb test at 70 °C for 96 h and 16 h at room temperature		N/A
	Insulating material in which heating conductors are embedded is considered to be basic insulation and not reinforced insulation		N/A
22.33	Conductive liquids that are or may become accessible in normal use are not in direct contact with live parts		N/A
	Electrodes not used for heating liquids		N/A
	For class II constructions, conductive liquids that are or may become accessible in normal use, not in direct contact with basic or reinforced insulation	Electric hobs, conductive liquids in users' vessels only.	N/A
	For class II constructions, conductive liquids which are in contact with live parts, not in direct contact with reinforced insulation		N/A
22.34	Shafts of operating knobs, handles, levers etc. not live, unless the shaft is not accessible when the part is removed		N/A
22.35	Handles, levers and knobs, held or actuated in normal use, not becoming live in the event of a failure of basic insulation		P
	Such parts being of metal, and their shafts or fixings are likely to become live in the event of a failure of basic insulation, are either adequately covered by insulation material or their accessible parts are separated from their shafts or fixings by supplementary insulation		N/A
	This requirement does not apply to handles, levers and knobs on stationary appliances other than those of electrical components, provided they are either reliably connected to an earthing terminal or earthing contact, or separated from live parts by earthed metal		N/A
22.36	Handles continuously held in the hand in normal use are so constructed that when gripped as in normal use, the operators hand is not likely to touch metal parts, unless they are separated from live parts by double or reinforced insulation		N/A
22.37	Capacitors in Class II appliances not connected to accessible metal parts, unless complying with 22.42		N/A

IEC 60335-2-6			
Clause	Requirement + Test	Result - Remark	Verdict
	Metal casings of capacitors in Class II appliances separated from accessible metal parts by supplementary insulation, unless complying with 22.42		N/A
22.38	Capacitors not connected between the contacts of a thermal cut-out		P
22.39	Lamp holders used only for the connection of lamps		N/A
22.40	Motor-operated appliances and combined appliances intended to be moved while in operation, or having accessible moving parts, fitted with a switch to control the motor. The actuating member of the switch being easily visible and accessible		N/A
	Unless the appliance can operate continuously, automatically or remotely without giving rise to a hazard, appliances for remote operation being fitted with a switch. The actuating member of the switch being easily visible and accessible.		N/A
22.41	No components, other than lamps, containing mercury		P
22.42	Protective impedance consisting of at least two separate components		N/A
	Values specified in 8.1.4 not exceeded if any one of the components are short-circuited or open-circuited		N/A
22.43	Appliances adjustable for different voltages, accidental changing of the setting of the voltage unlikely to occur		N/A
22.44	Appliances shall not have an enclosure that is shaped or decorated like a toy		P
22.45	When air is used as reinforced insulation, clearances not reduced below the values specified in 29.1.4 due to deformation as a result of an external force applied to the enclosure		P
22.46	Software used in protective electronic circuits is software class B or C		N/A
22.47	Appliances connected to the water mains withstand the water pressure expected in normal use		N/A
	No leakage from any part, including any inlet water hose		N/A
22.48	Appliances connected to the water mains constructed to prevent backsiphonage of non-potable water		N/A
22.49	For remote operation, the duration of operation shall be set before the appliance can be started, unless		N/A
	the appliance switches off automatically or can operate continuously without hazard		N/A

IEC 60335-2-6			
Clause	Requirement + Test	Result - Remark	Verdict
22.50	Controls incorporated in the appliance take priority over controls actuated by remote operation		N/A
22.51	A control on the appliance being manually adjusted to the setting for remote operation before the appliance can be operated in this mode		N/A
	There is a visual indication showing that the appliance is adjusted for remote operation		N/A
	Manual setting and visual indication not necessary on appliances that can operate as follows, without giving rise to a hazard:		-
	- operate continuously,		N/A
	- operate automatically, or		N/A
	- be operated remotely		N/A
	It is not necessary to manually adjust to the setting for remote operation in order to switch the appliance off. (IEC 60335-2-6)		N/A
22.52	Socket-outlets on appliances accessible to the user in accordance with the socket-outlet system used in the country in which the appliance is sold		N/A
22.101	Hob element prevented from rotating about vertical axis and (IEC 60335-2-6:2002)		P
	adequately supported in all positions of adjustment of their supports (IEC 60335-2-6:2002)		P
	Hobs constructed so that damage to is unlikely occur while the hob elements are being removed or replaced, for hobs with detachable hob elements (IEC 60335-2-6:2002)		N/A
22.102	Timers intended to delay the operation of a heating element shall not control a radiant grill, unless (IEC 60335-2-6:2002)		N/A
	the grill is thermally controlled and incorporated in an oven or other compartment (IEC 60335-2-6:2002)		N/A
22.103	Ovens vents shall be constructed so that any moisture or grease discharged through them cannot affect clearances and creepage distances between live parts and other parts of the appliance (IEC 60335-2-6:2002)		N/A
22.104	Steam ovens shall be constructed so that steam vents and ducts are unlikely to become blocked during normal use (IEC 60335-2-6:2002)		N/A
22.105	Built-in ovens shall only be vented through the front, unless (IEC 60335-2-6:2002)		N/A
	provision is made for venting through a duct (IEC 60335-2-6:2002)		N/A
22.106	Grills shall be constructed so that grill can be easily positioned without jamming (IEC 60335-2-6:2002)		N/A
	The grills pans shall not fall from the support when moved sideways (IEC 60335-2-6:2002)		N/A

IEC 60335-2-6			
Clause	Requirement + Test	Result - Remark	Verdict
22.107	Pyrolytic self-cleaning ovens shall switch off automatically at the end of the process and require a manual operation to start another cleaning cycle (IEC 60335-2-6:2002)		N/A
22.108	Pyrolytic self-cleaning ovens shall be constructed so that opening and closing of the door does not impair the interlock system or damage the door seal; test as specified (IEC 60335-2-6:2002)		N/A
	After the test, the interlock system shall be fit for further use and the door seal shall not be damage (IEC 60335-2-6:2002)		N/A
22.109	Pyrolytic self-cleaning ovens shall incorporate an interlock so that access to the oven cannot be gained when the temperature in the centre of the oven exceeds 350 °C. even if the interlock is defective; test as specified (IEC 60335-2-6:2002)		N/A
22.110	Pyrolytic self-cleaning ovens shall be constructed so that ignitable gases cannot be discharged through vents during the cleaning process; test as specified (IEC 60335-2-6:2002)		N/A
22.111	Pyrolytic self-cleaning ovens: no risk of emission of flames; test as specified (60335-2-6)		N/A
22.112	Hobs shall be constructed so that hinged lids cannot close accidentally (IEC 60335-2-6:2002)		N/A
22.113	Hobs shall be constructed so that inadvertent operation of touch controls due to spillage of liquid or damp cloth is unlikely; test as specified (IEC 60335-2-6:2002)		P
22.114	Hobs having touch controls shall require at least two manual operations to switch on a hob element but only one to switch off (IEC 60335-2-6:2002)		P
	Additional hob elements may be switched on by single manual operation (IEC 60335-2-6:2002)		N/A
	Hobs having touch controls shall incorporate visual means to indicate when each hob is energized (IEC 60335-2-6:2002)		P
22.115	Induction hob elements and induction wok elements, and other hob elements incorporating a pan detector shall be constructed so that the hob element operated can only be operated when a vessel is placed on the cooking zone (IEC 60335-2-6:2002)		N/A
	Appliance operated at rated voltage: (IEC 60335-2-6:2002)		N/A
	Temperature rise not exceed 35 K, for induction hob elements and induction wok elements: (IEC 60335-2-6:2002)		N/A
	Other hobs elements shall not operate (IEC 60335-2-6:2002)		N/A
22.116	Hob elements incorporating a pan detector shall be constructed so that the hob element is not switched on by the vessel if it has been removed for more than 10 min (IEC 60335-2-6:2002)		N/A

IEC 60335-2-6			
Clause	Requirement + Test	Result - Remark	Verdict
22.117	Appliances incorporating a pan detector a signal lamp shall indicate when the control for the hob elements is not switched to the off position (IEC 60335-2-6:2002)		N/A
22.118	If a plug of a supply cord is engaged in a socket-outlet located directly above the door, it shall not be possible to operate a grill (IEC 60335-2-6:2002)		N/A
22.119	Cooking ranges incorporating a retractable deflector to prevent excessive temperatures on control knobs shall be constructed so that the user is unlikely to touch hot surfaces of the deflector when operating the controls (IEC 60335-2-6:2002)		N/A
22.120	Outer glass panels of oven doors shall be made from glass that breaks into small pieces when it fractures (IEC 60335-2-6:2002)		N/A
22.121	Outer glass panels of oven doors that are intended to be removed by the user for cleaning shall be constructed so that they cannot be fixed in an incorrect orientation (IEC 60335-2-6:2002)		N/A
22.122	Ovens with shelves that can be withdrawn shall be fitted with rest positions (IEC 60335-2-6:2002)		N/A
	The shelves shall also be constructed to prevent cooking dishes, or the like, from sliding over the rear edge (IEC 60335-2-6:2002)		N/A

23	INTERNAL WIRING		
23.1	Wireways smooth and free from sharp edges		P
	Wires protected against contact with burrs, cooling fins etc.		P
	Wire holes in metal well rounded or provided with bushings		P
	Wiring effectively prevented from coming into contact with moving parts		N/A
23.2	Beads etc. on live wires cannot change their position, and are not resting on sharp edges or corners		N/A
	Beads inside flexible metal conduits contained within an insulating sleeve		N/A
23.3	Electrical connections and internal conductors movable relatively to each other not exposed to undue stress		N/A
	Flexible metallic tubes not causing damage to insulation of conductors		N/A
	Open-coil springs not used		N/A
	Adequate insulating lining provided inside a coiled spring, the turns of which touch one another		N/A

IEC 60335-2-6			
Clause	Requirement + Test	Result - Remark	Verdict
	No damage after 10 000 flexings for conductors flexed during normal use or 100 flexings for conductors flexed during user maintenance		N/A
	Electric strength test of 16.3, 1000 V between live parts and accessible metal parts		N/A
	Not more than 10% of the strands of any conductor broken, and		N/A
	not more than 30% for wiring supplying circuits that consume no more than 15W		N/A
	The requirement also applies if parts of a cooking range are folded onto the hob surface or separated from their normal position, for transportation purposes (IEC 60335-2-6:2002)		N/A
23.4	Bare internal wiring sufficiently rigid and fixed		N/A
23.5	The insulation of internal wiring withstanding the electrical stress likely to occur in normal use		P
	No breakdown when a voltage of 2000 V is applied for 15 min between the conductor and metal foil wrapped around the insulation		P
23.6	Sleeving used as supplementary insulation on internal wiring retained in position by clamping at both ends, or		N/A
	be such that it can only be removed by breaking or cutting		N/A
23.7	The colour combination green/yellow used only for earthing conductors		P
23.8	Aluminium wires not used for internal wiring		P
23.9	No lead-tin soldering of stranded conductors where they are subject to contact pressure, unless		P
	clamping means so constructed that there is no risk of bad contact due to cold flow of the solder		N/A
23.10	The insulation and sheath of internal wiring, incorporated in external hoses for the connection of an appliance to the water mains, at least equivalent to that of light polyvinyl chloride sheathed flexible cord (60227 IEC 52)		N/A
24	COMPONENTS		
24.1	Components comply with safety requirements in relevant IEC standards		P
	List of components	(see appended table)	P

IEC 60335-2-6				
Clause	Requirement + Test	Result - Remark	Verdict	
	Components not tested and found to comply with relevant IEC standard for the number of cycles specified are tested in accordance with 24.1.1 to 24.1.9		P	
	Components not tested and found to comply with relevant IEC standard, components not marked or not used in accordance with its marking, tested under the conditions occurring in the appliance		P	
	Lampholders and starterholders not being tested and found to comply with the relevant IEC standard, tested as a part of the appliance and additionally according to the gauging and interchangeability requirements of the relevant IEC standard		N/A	
24.1.1	Capacitors likely to be permanently subjected to the supply voltage and used for radio interference suppression or for voltage dividing, complying with IEC 60384-14, or		P	
	tested according to annex F		N/A	
24.1.2	Safety isolating transformers complying with IEC 61558-2-6, or		N/A	
	tested according to annex G		N/A	
24.1.3	Switches complying with IEC 61058-1, the number of cycles of operation being at least 10 000, or		P	
	tested according to annex H		N/A	
	If the switch operates a relay or contactor, the complete switching system is subjected to the test		N/A	
	Switches controlling hob elements subjected to 30 000 cycles of operation (IEC 60335-2-6:2002)		P	
24.1.4	Automatic controls complying with IEC 60730-1 with relevant part 2. The number of cycles of operation being:		-	
	- thermostats:	10 000	Separate approved	P
	- temperature limiters:	1 000		N/A
	- self-resetting thermal cut-outs:	300		N/A
	- self-resetting thermal cut-outs for heating elements of glass-ceramic hobs (IEC 60335-2-6:2002)	100 000		N/A
	- self-resetting thermal cut-outs for heating elements of other hobs (IEC 60335-2-6:2002)	10 000		N/A
	- voltage maintained non-self-resetting thermal cut-outs:	1000		N/A
	- other non-self-resetting thermal cut-outs:	30		N/A
	- timers:	3 000		N/A

IEC 60335-2-6			
Clause	Requirement + Test	Result - Remark	Verdict
	- energy regulators for automatic action (IEC 60335-2-6:2002)	100 000	N/A
	- energy regulators for manual action (IEC 60335-2-6:2002)	10 000	N/A
	thermostats controlling the cleaning process in pyrolytic self-cleanings ovens (IEC 60335-2-6:2002)	3 000	N/A
	Thermal motor protectors are tested in combination with their motor under the conditions specified in Annex D		N/A
	For water valves containing live parts and that are incorporated in external hoses for connection of an appliance to the water mains, the degree of protection declared for subclause 6.5.2 of IEC 60730-2-8 is IPX7		N/A
24.1.5	Appliance couplers complying with IEC 60320-1		N/A
	However, appliances classified higher than IPX0, the appliance couplers complying with IEC 60320-2-3		N/A
	Interconnection couplers complying with IEC 60320-2-2		N/A
24.1.6	Small lamp holders similar to E10 lampholders complying with IEC 60238, the requirements for E10 lampholders being applicable		N/A
24.1.7	If the remote operation of the appliance is via a telecommunication network, the relevant standard for the telecommunication interface circuitry in the appliance is IEC 62151		N/A
24.1.8	The relevant standard for thermal links is IEC 60691. Thermal links not complying with IEC 60691 are considered to be an intentionally weak part for the purposes of Clause 19		N/A
24.1.9	Relays, other than motor starting relays, tested as part of the appliance		P
	They are also tested in accordance with Clause 17 of IEC 60730-1, the number of operations in 24.1.4 selected according to the relay function in the appliance..... :	10 000	P
24.2	No switches or automatic controls in flexible cords		P
	No devices causing the protective device in the fixed wiring to operate in the event of a fault in the appliance		P
	No thermal cut-outs that can be reset by soldering unless		N/A
	the solder has a melting point of at least 230 °C		N/A

IEC 60335-2-6			
Clause	Requirement + Test	Result - Remark	Verdict
24.3	Switches intended for all-pole disconnection of stationary appliances are directly connected to the supply terminals and having a contact separation in all poles, providing full disconnection under overvoltage category III conditions		N/A
24.4	Plugs and socket-outlets for extra-low voltage circuits and heating elements, not interchangeable with plugs and socket-outlets listed in IEC 60083 or IEC 60906-1 or with connectors and appliance inlets complying with the standard sheets of IEC 60320-1		N/A
24.5	Capacitors in auxiliary windings of motors marked with their rated voltage and capacitance and used accordingly		N/A
	Voltage across capacitors in series with a motor winding does not exceed 1,1 times rated voltage, when the appliance is supplied at 1,1 times rated voltage under minimum load		N/A
24.6	Working voltage of motors connected to the supply mains and having basic insulation that is inadequate for the rated voltage of the appliance, not exceeding 42V		N/A
	In addition, the motors are complying with the requirements of Annex I		N/A
24.7	Detachable hose-sets for connection of appliances to the water mains comply with IEC 61770		N/A
	They are supplied with the appliance		N/A
	Appliances intended to be permanently connected to the water mains not connected by a detachable hose-set		N/A
24.8	Motor running capacitors in appliances for which 30.2.3 is applicable and that are permanently connected in series with a motor winding, not causing a hazard in event of a failure		N/A
	One or more of the following conditions are to be met:		N/A
	- the capacitors are of class P2 according to IEC 60252-1		N/A
	- the capacitors are housed within a metallic or ceramic enclosure		N/A
	- the distance of separation of the outer surface to adjacent non-metallic parts exceeds 50 mm		N/A
	- adjacent non-metallic parts within 50 mm withstand the needle-flame test of Annex E		N/A
	- adjacent non-metallic parts within 50 mm classified as at least V-1 according to IEC 60695-11-10		N/A

IEC 60335-2-6			
Clause	Requirement + Test	Result - Remark	Verdict
24.101	Thermostat and energy regulators incorporating an off position shall not switch on a result of variations in ambient temperatures (IEC 60335-2-6:2002)	For model type "R", "M" only.	P
	During the test, the off position shall be maintained		P
	No breakdown shall occur; test voltage 500 V		P
24.102	Incorporated socket-outlets in cooking ranges: single-phase type, earthing contact, rated current ≤16 A, protected by fuses or circuit breaker placed behind a non-detachable cover rated current not exceeding rated current of the socket-outlet (IEC 60335-2-6:2002)		N/A
	Cooking range for permanently connected to fixed wiring or is fitted with a polarized plug, the neutral pole need not be protected (IEC 60335-2-6:2002)		N/A
	If fuses become accessible after opening a drawer or other compartment, a non-detachable cover is not required (IEC 60335-2-6:2002)		N/A

25	SUPPLY CONNECTION AND EXTERNAL FLEXIBLE CORDS		
25.1	Appliance not intended for permanent connection to fixed wiring, means for connection to the supply:		-
	- supply cord fitted with a plug		N/A
	- an appliance inlet having at least the same degree of protection against moisture as required for the appliance		N/A
	- pins for insertion into socket-outlets		N/A
25.2	Appliance not provided with more than one means of connection to the supply mains		P
	Stationary appliance for multiple supply may be provided with more than one means of connection, provided electric strength test of 1250 V for 1 min between each means of connection causes no breakdown		N/A
25.3	Appliance intended to be permanently connected to fixed wiring provided with one of the following means for connection to the supply mains:		P
	- a set of terminals allowing the connection of a flexible cord		P
	- a fitted supply cord		P
	- a set of supply leads accommodated in a suitable compartment		N/A
	- a set of terminals for the connection of cables of fixed wiring, cross-sectional areas specified in 26.6, and the appliance allows the connection of the supply conductors after the appliance has been fixed to its support		N/A

IEC 60335-2-6			
Clause	Requirement + Test	Result - Remark	Verdict
	- a set of terminals and cable entries, conduit entries, knock-outs or glands, allowing connection of appropriate types of cable or conduit, and the appliance allows the connection of the supply conductors after the appliance has been fixed to its support		N/A
	For a fixed appliance constructed so that parts can be removed to facilitate easy installation, this requirement is met if it is possible to connect the fixed wiring without difficulty after a part of the appliance has been fixed to its support		N/A
	Connection of supply wires of hobs, built-in ranges and built-in ovens may be made before the appliance is installed (IEC 60335-2-6:2002)		P
25.4	Cable and conduit entries, rated current of appliance not exceeding 16 A, dimension according to table 10		N/A
	Introduction of conduit or cable does not reduce clearances or creepage distances below values specified in 29		N/A
25.5	Method for assemble supply cord with the appliance:		-
	- type X attachment		P
	- type Y attachment		N/A
	- type Z attachment, if allowed in part 2		N/A
	Type X attachment, other than those with a specially prepared cord, not used for flat twin tinsel cords		P
	For multi-phase appliances supplied with a supply cord and that are intended to be permanently connected to fixed wiring, the supply cord is assembled to the appliance by type Y attachment		N/A
25.6	Plugs fitted with only one flexible cord		N/A
25.7	Supply cords being one of the following types:		-
	- rubber sheathed (at least 60245 IEC 53)	H05RR-F H05BB-F	P
	- polychloroprene sheathed (at least 60245 IEC 57)		N/A
	- cross-linked polyvinyl chloride sheathed (at least 60245 IEC 87)		N/A
	Polyvinyl chloride sheathed: Not used if they are likely to touch metal parts having a temperature rise exceeding 75K during the test of Clause 11.		-
	- light polyvinyl chloride sheathed cord (at least 60227 IEC 52), appliances not exceeding 3 kg		N/A
	- ordinary polyvinyl chloride sheathed cord (at least 60227 IEC 53), other appliances		N/A

IEC 60335-2-6			
Clause	Requirement + Test	Result - Remark	Verdict
	Heat resistant polyvinyl chloride sheathed: Not used for type X attachment other than specially prepared cords.		-
	- Heat-resistant light polyvinyl chloride sheathed cord (at least 60227 IEC 56), appliances not exceeding 3 kg		N/A
	- heat-resistant polyvinyl chloride sheathed cord (60227 IEC 57), other appliances		N/A
	Supply cords for class III appliances adequately insulated		N/A
	Test with 500 V for 2 min for supply cords of class III appliances that contain live parts		N/A
25.8	Nominal cross-sectional area of supply cords according to table 11; rated current (A); cross-sectional area (mm ²)	4 heating elements sample: Max rated current: 30.9A; (diversity factor F=0.675 taken into account) 30.9A x 0.675 = 20.86A Cross section: 2.5mm ² 3 Heating elements sample: Max rated current: 24.59A; Cross section: 2.5mm ²	P
25.9	Supply cord not in contact with sharp points or edges		P
25.10	Green/yellow core for earthing purposes in Class I appliance		P
25.11	Conductors of supply cords not consolidated by lead-tin soldering where they are subject to contact pressure, unless		P
	clamping means so constructed that there is no risk of bad contacts due to cold flow of the solder		N/A
25.12	Moulding the cord to part of the enclosure does not damage the insulation of the supply cord		N/A
25.13	Inlet opening so shaped as to prevent damage to the supply cord		P
	Unless the enclosure at the inlet opening is of insulation material, a non-detachable lining or bushing complying with 29.3 for supplementary insulation provided	Inlet opening is of insulating material	N/A
	If unsheathed supply cord, a similar additional bushing or lining is required, unless		N/A
	the appliance is class 0, or		N/A
	a class III appliance not containing live parts		N/A
25.14	Supply cords adequately protected against excessive flexing		N/A
	Flexing test:		N/A

IEC 60335-2-6			
Clause	Requirement + Test	Result - Remark	Verdict
	- applied force (N)		N/A
	- number of flexings		N/A
	The test does not result in:		N/A
	- short circuit between the conductors		N/A
	- breakage of more than 10% of the strands of any conductor		N/A
	- separation of the conductor from its terminal		N/A
	- loosening of any cord guard		N/A
	- damage, within the meaning of the standard, to the cord or the cord guard		N/A
	- broken strands piercing the insulation and becoming accessible		N/A
	For temperature-sensing probes, the total number of flexings is 5 000. (IEC 60335-2-6:2002)		N/A
	Probes with circular section cords are turned through 90° after 2 500 flexings(IEC 60335-2-6:2002)		N/A
25.15	Conductors of the supply cord relieved from strain, twisting and abrasion by use of cord anchorage		P
	The cord cannot be pushed into the appliance to such an extent that the cord or internal parts of the appliance can be damaged		P
	Pull and torque test of supply cord, values shown in table 10: pull (N); torque (not on automatic cord reel) (Nm)	Pull: 100N Torque: 0.35Nm	P
	Cord not damaged and max. 2 mm displacement of the cord		P
25.16	Cord anchorages for type X attachments constructed and located so that:		-
	- replacement of the cord is easily possible		P
	- it is clear how the relief from strain and the prevention of twisting are obtained		P
	- they are suitable for different types of cord		P
	- cord cannot touch the clamping screws of cord anchorage if these screws are accessible, unless separated from accessible metal parts by supplementary insulation		P
	- the cord is not clamped by a metal screw which bears directly on the cord		P
	- at least one part of the cord anchorage securely fixed to the appliance, unless part of a specially prepared cord		P

IEC 60335-2-6			
Clause	Requirement + Test	Result - Remark	Verdict
	- screws which have to be operated when replacing the cord do not fix any other component, if applicable		P
	- if labyrinths can be bypassed the test of 25.15 is nevertheless withstood		N/A
	- for Class 0, 0I and I appliances: they are of insulating material or are provided with an insulating lining, unless a failure of the insulation of the cord does not make accessible metal parts live		P
	- for Class II appliances: they are of insulating material, or if of metal, they are insulated from accessible metal parts by supplementary insulation		N/A
	After the test of 25.15, under the conditions specified, the conductors have not moved by more than 1 mm in the terminals		P
25.17	Adequate cord anchorages for type Y and Z attachment		N/A
25.18	Cord anchorages only accessible with the aid of a tool, or		N/A
	so constructed that the cord can only be fitted with the aid of a tool		P
25.19	Type X attachment, glands not used as cord anchorage in portable appliances		N/A
	Tying the cord into a knot or tying the cord with string not used		P
25.20	Conductors of the supply cord for type Y and Z attachment adequately additionally insulated		N/A
25.21	Space for supply cord for type X attachment or for connection of fixed wiring constructed to permit checking of conductors with respect to correct positioning and connection before fitting any cover, no risk of damage to the conductors when fitting the cover, no contact with accessible metal parts if a conductor becomes loose, etc.		P
	For portable appliances, the uninsulated end of a conductor prevented from any contact with accessible metal parts, unless the end of the cord is such that the conductors are unlikely to slip free		N/A
25.22	Appliance inlet:		-
	- live parts not accessible during insertion or removal		N/A
	- connector can be inserted without difficulty		N/A
	- the appliance is not supported by the connector		N/A

IEC 60335-2-6			
Clause	Requirement + Test	Result - Remark	Verdict
	- is not for cold conditions if temp. rise of external metal parts exceeds 75 K, unless the supply cord is not likely to touch such metal parts		N/A
25.23	Interconnection cords comply with the requirements for the supply cord, except as specified		N/A
	If necessary, electric strength test of 16.3		N/A
25.24	Interconnection cords not detachable without the aid of a tool if compliance with the standard is impaired when they are disconnected		N/A
25.25	Dimensions of pins compatible with the dimensions of the relevant socket-outlet. Dimensions of pins and engagement face in accordance with the relevant plug in IEC 60083		N/A

26	TERMINALS FOR EXTERNAL CONDUCTORS		
26.1	Appliances provided with terminals or equally effective devices for connection of external conductors		P
	Terminals only accessible after removal of a non-detachable cover		P
	for class III appliances that do not contain live parts		N/A
	Earthing terminals may be accessible if a tool is required to make the connections and means are provided to clamp the wire independently from its connection		P
26.2	Appliances with type X attachment and appliances for connection to fixed wiring provided with terminals in which connections are made by means of screws, nuts or similar devices, unless the connections are soldered		P
	Screws and nuts serve only to clamp supply conductors, except		P
	internal conductors, if so arranged that they are unlikely to be displaced when fitting the supply conductors		N/A
	If soldered connections used, the conductor so positioned or fixed that reliance is not placed on soldering alone, unless		N/A
	barriers provided so that neither clearances nor creepage distances between live parts and other metal parts reduced below the values for supplementary insulation if the conductor becomes free at the soldered joint		N/A

IEC 60335-2-6			
Clause	Requirement + Test	Result - Remark	Verdict
26.3	Terminals for type X attachment and for connection of cables of fixed wiring so constructed that the conductor is clamped between metal surfaces with sufficient contact pressure but without damaging the conductor		P
	Terminals fixed so that when the clamping means is tightened or loosened:		-
	- the terminal does not become loose		P
	- internal wiring is not subjected to stress		P
	- neither clearances nor creepage distances are reduced below the values in clause 29		P
	Compliance checked by inspection and by the test of subclause 9.6 of IEC 60999-1, the torque applied being equal to two-thirds of the torque specified (Nm)	Diameter of screws: 3,8mm Torque applied: 1,2Nm * 2/3 = 0,8Nm	P
26.4	Terminals for type X attachment, except those with a specially prepared cord, and those for connection to fixed wiring, no special preparation of conductors required, and so constructed or placed that conductors prevented from slipping out		P
26.5	Terminals for type X attachment so located or shielded that if a wire of a stranded conductor escapes, no risk of accidental connection to other parts that result in a hazard		P
	Stranded conductor test, 8 mm insulation removed		P
	No contact between live parts and accessible metal parts and, for class II constructions, between live parts and metal parts separated from accessible metal parts by supplementary insulation only		P
26.6	Terminals for type X attachment and for connection to fixed wiring suitable for connection of conductors with required cross-sectional area according to table 13; rated current (A); nominal cross-sectional area (mm ²)	2.5mm ² and 4mm ²	P
	Terminals only suitable for a specially prepared cord		N/A
26.7	Terminals for type X attachment accessible after removal of a cover or part of the enclosure		P
26.8	Terminals for the connection to fixed wiring, including the earthing terminal, located close to each other		P
26.9	Terminals of the pillar type constructed and located as specified		P
26.10	Terminals with screw clamping and screwless terminals not used for flat twin tinsel cords, unless conductors ends fitted with a device suitable for screw terminals		N/A
	Pull test of 5 N to the connection		N/A

IEC 60335-2-6			
Clause	Requirement + Test	Result - Remark	Verdict
26.11	For type Y and Z attachment: soldered, welded, crimped and similar connections may be used		N/A
	For Class II appliances: the conductor so positioned or fixed that reliance is not placed on soldering, welding or crimping alone		N/A
	If soldering, welding or crimping alone used, barriers provided so that clearances and creepage distances between live parts and other metal parts are not reduced below the values for supplementary insulation if the conductor becomes free		N/A

27	PROVISION FOR EARTHING		
27.1	Accessible metal parts of Class 0I and I appliances, permanently and reliably connected to an earthing terminal or contact of the appliance inlet		P
	Earthing terminals not connected to neutral terminal		P
	Class 0, II and III appliance have no provision for earthing		N/A
	Safety extra-low voltage circuits not earthed, unless protective extra-low voltage circuits		N/A
27.2	Clamping means adequately secured against accidental loosening		P
	Terminals used for the connection of external equipotential bonding conductors allow connection of conductors of 2.5 to 6 mm ² , and		N/A
	do not provide earthing continuity between different parts of the appliance		N/A
	Conductors cannot be loosened without the aid of a tool		N/A
27.3	For detachable parts that are plugged into another part of the appliance, and having an earth connection, the earth connection made before and separated after current-carrying connections when removing the part		N/A
	For appliances with supply cord, current-carrying conductors become taut before earthing conductor, if the cord slips out of the cord anchorage		P
27.4	No risk of corrosion resulting from contact between metal of earthing terminal and other metal		P
	Adequate resistance to corrosion of coated or uncoated parts providing earthing continuity, other than parts of a metal frame or enclosure		N/A

IEC 60335-2-6			
Clause	Requirement + Test	Result - Remark	Verdict
	Parts of steel providing earthing continuity provided at the essential areas with an electroplated coating, thickness at least 5 µm		N/A
	Adequate protection against rusting of parts of coated or uncoated steel, only intended to provide or transmit contact pressure		P
	In case of aluminium alloys precautions taken to avoid risk of corrosion		N/A
27.5	Low resistance of connection between earthing terminal and earthed metal parts		P
	This requirement does not apply to connections providing earthing continuity in the protective extra-low voltage circuit, provided that clearances of basic insulation are based on the rated voltage of the appliance		P
	Resistance not exceeding 0,1 Ω at the specified low-resistance test	0.05Ω	P
27.6	The printed conductors of printed circuit boards shall not be used to provide earthing continuity in hand-held appliances.		N/A
	They may be used to provide earthing continuity in other appliances if at least two tracks are used with independent soldering points and the appliance complies with 27.5 for each circuit		N/A

28	SCREWS AND CONNECTIONS		
28.1	Fixings, electrical connections and connections providing earthing continuity withstand mechanical stresses		P
	Screws not of soft metal liable to creep, such as zinc or aluminium		P
	Diameter of screws of insulating material min. 3 mm		N/A
	Screws of insulating material not used for any electrical connection or connections providing earthing continuity		N/A
	Screws used for electrical connections or connections providing earthing continuity screw into metal		P
	Screws not of insulating material if their replacement by a metal screw can impair supplementary or reinforced insulation		N/A
	Type X attachment, screws to be removed for replacement of supply cord or for user maintenance, not of insulating material if their replacement by a metal screw can impair basic insulation		N/A

IEC 60335-2-6			
Clause	Requirement + Test	Result - Remark	Verdict
	For screws and nuts; test as specified	(see appended table)	P
28.2	Electrical connections and connections providing earthing continuity constructed so that contact pressure not transmitted through insulating material liable to shrink or distort, unless shrinkage or distortion compensated		P
	This requirement does not apply to electrical connections in circuits of appliances for which:		-
	<ul style="list-style-type: none"> 30.2.2 is applicable and that carry a current not exceeding 0,5 A 		N/A
	<ul style="list-style-type: none"> 30.2.3 is applicable and that carry a current not exceeding 0,2 A 		N/A
28.3	Space-threaded (sheet metal) screws only used for electrical connections if they clamp the parts together		N/A
	Thread-cutting (self-tapping) screws and thread rolling screws only used for electrical connections if they generate a full form standard machine screw thread		N/A
	Thread-cutting (self-tapping) screws not used if they are likely to be operated by the user or installer		N/A
	Thread-cutting, thread rolling and space threaded screws may be used in connections providing earthing continuity provided it is not necessary to disturb the connection:		N/A
	- in normal use,		N/A
	- during user maintenance,		N/A
	- when replacing a supply cord having a type X attachment, or		N/A
	- during installation		N/A
	At least two screws being used for each connection providing earthing continuity, unless		N/A
	the screw forms a thread having a length of at least half the diameter of the screw		P
28.4	Screws and nuts that make mechanical connection secured against loosening if they also make electrical connections or connections providing earthing continuity		P
	This requirement does not apply to screws in the earthing circuit if at least two screws are used, or		N/A
	if an alternative earthing circuit is provided		N/A
	Rivets for electrical connections or connections providing earthing continuity secured against loosening if the connections are subjected to torsion		N/A

IEC 60335-2-6			
Clause	Requirement + Test	Result - Remark	Verdict
29	CLEARANCES, CREEPAGE DISTANCES AND SOLID INSULATION		
	Clearances, creepage distances and solid insulation withstand electrical stress		P
	For coatings used on printed circuits boards to protect the microenvironment (Type 1) or to provide basic insulation (Type 2), annex J applies :		N/A
	The microenvironment is pollution degree 1 under Type 1 coating		N/A
	For type 2 protection, the spacing between the conductors before the protection is applied is not less than the values specified in Table 1 of IEC 60664-3		N/A
	These values apply to functional, basic, supplementary and reinforced insulation :		N/A
29.1	Clearances not less than the values specified in table 16, taking into account the rated impulse voltage for the overvoltage categories of table 15, unless		P
	for basic insulation and functional insulation they comply with the impulse voltage test of clause 14		N/A
	However, if the construction is affected by wear, distortion, movement of the parts or during assembly, the clearances for rated impulse voltages of 1500V and above are increased by 0,5 mm and the impulse voltage test is not applicable		P
	Impulse voltage test not applicable:		-
	- when the microenvironment is pollution degree 3		N/A
	- for basic insulation of class 0 and class 01 appliances		N/A
	Appliances are in overvoltage category II		P
	A force of 2 N is applied to bare conductors, other than heating elements		N/A
	A force of 30 N is applied to accessible surfaces		N/A
29.1.1	Clearances of basic insulation withstand the overvoltages, taking into account the rated impulse voltage		P
	Clearance at the terminals of tubular sheathed heating elements may be reduced to 1mm if the microenvironment is pollution degree 1		N/A
	Lacquered conductors of windings considered to be bare conductors		P
29.1.2	Clearances of supplementary insulation not less than those specified for basic insulation in table 16		N/A

IEC 60335-2-6			
Clause	Requirement + Test	Result - Remark	Verdict
29.1.3	Clearances of reinforced insulation not less than those specified for basic insulation in table 16, but using the next higher step for rated impulse voltage		P
	For double insulation, with no intermediate conductive part between basic and supplementary insulation, clearances are measured between live parts and the accessible surface, and the insulation system is treated as reinforced insulation		N/A
29.1.4	Clearances for functional insulation are the largest values determined from:		-
	- table 16 based on the rated impulse voltage	(see appended table)	P
	- table F.7a in IEC 60664-1, frequency not exceeding 30 kHz		N/A
	- clause 4 of IEC 60664-4, frequency exceeding 30 kHz		N/A
	If values of table 16 are largest, the impulse voltage test of clause 14 may be applied instead, unless		N/A
	the microenvironment is pollution degree 3, or		N/A
	the distances can be affected by wear, distortion, movement of the parts or during assembly		N/A
	However, clearances are not specified if the appliance complies with clause 19 with the functional insulation short-circuited		N/A
	Lacquered conductors of windings considered to be bare conductors		P
	However, clearances at crossover points are not measured		P
	Clearance between surfaces of PTC heating elements may be reduced to 1mm		N/A
29.1.5	Appliances having higher working voltages than rated voltage, clearances for basic insulation are the largest values determined from:		-
	- table 16 based on the rated impulse voltage		N/A
	- table F.7a in IEC 60664-1, frequency not exceeding 30 kHz		N/A
	- clause 4 of IEC 60664-4, frequency exceeding 30 kHz		N/A
	If clearances for basic insulation are selected from Table F.7a of IEC 60664-1 or Clause 4 of IEC 60664-4, the clearances of supplementary insulation are not less than those specified for basic insulation		N/A
	If clearances for basic insulation are selected from Table F.7a of IEC 60664-1, the clearances of reinforced insulation dimensioned as specified in Table F.7a are to withstand 160% of the withstand voltage required for basic insulation		N/A

IEC 60335-2-6			
Clause	Requirement + Test	Result - Remark	Verdict
	If clearances for basic insulation are selected from Clause 4 of IEC 60664-4, the clearances of reinforced insulation are twice the value required for basic insulation		N/A
	If the secondary winding of a step-down transformer is earthed, or if there is an earthed screen between the primary and secondary windings, clearances of basic insulation on the secondary side not less than those specified in table 16, but using the next lower step for rated impulse voltage		N/A
	Circuits supplied with a voltage lower than rated voltage, clearances of functional insulation are based on the working voltage used as the rated voltage in table 15		N/A
29.2	Creepage distances not less than those appropriate for the working voltage, taking into account the material group and the pollution degree		
	Pollution degree 2 applies, unless		P
	precautions taken to protect the insulation; pollution degree 1		N/A
	insulation subjected to conductive pollution; pollution degree 3		N/A
	A force of 2 N is applied to bare conductors, other than heating elements		N/A
	A force of 30 N is applied to accessible surfaces		N/A
	In a double insulation system, the working voltage for both the basic and supplementary insulation is taken as the working voltage across the complete double insulation system		P
	The microenvironment is pollution degree 3 unless the insulation is enclosed or located so that it is unlikely to be exposed to pollution during normal use of the appliance (IEC 60335-2-6:2002) (IEC 60335-2-13:2002)		N/A
29.2.1	Creepage distances of basic insulation not less than specified in table 17		P
	However, if the working voltage is periodic and has a frequency exceeding 30 kHz, the creepage distances are also determined from table 2 of IEC 60664-4, these values being used if exceeding the values in table 17		N/A
	Except for pollution degree 1, corresponding creepage distance not less than the minimum specified for the clearance in table 16, if the clearance has been checked according to the test of clause 14.....		N/A

IEC 60335-2-6			
Clause	Requirement + Test	Result - Remark	Verdict
29.2.2	Creepage distances of supplementary insulation at least as specified for basic insulation in table 17, or		N/A
	Table 2 of IEC 60664-4, as applicable:		N/A
29.2.3	Creepage distances of reinforced insulation at least double as specified for basic insulation in table 17, or		P
	Table 2 of IEC 60664-4, as applicable:		N/A
29.2.4	Creepage distances of functional insulation not less than specified in table 18		P
	However, if the working voltage is periodic and has a frequency exceeding 30 kHz, the creepage distances are also determined from table 2 of IEC 60664-4, these values being used if exceeding the values in table 18:		N/A
	Creepage distances may be reduced if the appliance complies with clause 19 with the functional insulation short-circuited		N/A
29.3	Supplementary and reinforced insulation having adequate thickness, or a sufficient number of layers, to withstand the electrical stresses		P
	Compliance checked by:		-
	- measurement, in accordance with 29.3.1, or		P
	- an electric strength test in accordance with 29.3.2, or		N/A
	- an assessment of the thermal quality of the material combined with an electric strength test, in accordance with 29.3.3		N/A
	for accessible parts of reinforced insulation consisting of a single layer, by measurement in accordance with 29.3.4, or		N/A
	- as specified in subclause 6.3 of IEC 60664-4 for insulation that is subjected to any periodic voltage having a frequency exceeding 30 kHz		N/A
	This requirement does not apply to the sheath of visibly glowing heating element inaccessible to test probe 41 of IEC 61032 (IEC 60335-2-6:2002)		N/A
29.3.1	Supplementary insulation having a thickness of at least 1 mm		N/A
	Reinforced insulation having a thickness of at least 2 mm		P
29.3.2	Each layer of material withstand the electric strength test of 16.3 for supplementary insulation		N/A
	Supplementary insulation consisting of at least 2 layers		N/A

IEC 60335-2-6			
Clause	Requirement + Test	Result - Remark	Verdict
	Reinforced insulation consisting of at least 3 layers		N/A
29.3.3	The insulation is subjected to the dry heat test Bb of IEC 60068-2-2, followed by		N/A
	the electric strength test of 16.3		N/A
	If the temperature rise during the tests of Clause 19 does not exceed the value specified in Table 3, the test of IEC 60068-2-2 is not carried out		N/A
29.3.4	Thickness of accessible parts of reinforced insulation consisting of a single layer not less than specified in table 19..... :		N/A

30	RESISTANCE TO HEAT AND FIRE		
30.1	External parts of non-metallic material,		P
	parts supporting live parts, and		P
	thermoplastic material providing supplementary or reinforced insulation,		N/A
	sufficiently resistant to heat		P
	Ball-pressure test according to IEC 60695-10-2		P
	External parts: at 40 °C plus the maximum temperature rise determined during the test of clause 11, or at 75 °C, whichever is the higher; temperature (°C)..... :	(see appended table)	P
	Parts supporting live parts: at 40°C plus the maximum temperature rise determined during the test of clause 11, or at 125°C, whichever is the higher; temperature (°C)..... :	(see appended table)	P
	Parts of thermoplastic material providing supplementary or reinforced insulation, 25°C plus the maximum temperature rise determined during clause 19, if higher; temperature (°C)..... :		N/A
30.2	Parts of non-metallic material adequately resistant to ignition and spread of fire		P
	This requirement does not apply to:		-
	parts having a mass not exceeding 0,5 g, provided the cumulative effect is unlikely to propagate flames that originate inside the appliance by propagating flames from one part to another, or		N/A
	decorative trims, knobs and other parts unlikely to be ignited or to propagate flames that originate inside the appliance		N/A
	Compliance checked by the test of 30.2.1. In addition:		P

IEC 60335-2-6			
Clause	Requirement + Test	Result - Remark	Verdict
	- attended appliances, 30.2.2 applies		N/A
	- unattended appliances, 30.2.3 applies		P
	Appliances for remote operation, 30.2.3 applies		N/A
	Base material of printed circuit board, 30.2.4 applies		P
	For induction wok elements, grills and griddles that do not incorporate a timer , 30.2.2 is applicable (IEC 60335-2-6:2002)		N/A
	For other appliances, 30.2.3 is applicable (IEC 60335-2-6:2002)		P
30.2.1	Parts of non-metallic material subjected to the glow-wire test of IEC 60695-2-11 at 550 °C		P
	However, test not carried out if the material is classified as having a glow-wire flammability index according to IEC 60695-2-12 of at least 550 °C, or		N/A
	the material is classified at least HB40 according to IEC 60695-11-10		N/A
	Parts for which the glow-wire test cannot be carried out need to meet the requirements in ISO 9772 for material classified HBF		N/A
30.2.2	Appliances operated while attended, parts of non-metallic material supporting current-carrying connections, and parts of non-metallic material within a distance of 3mm of such connections, are subjected to the glow-wire test of IEC 60695-2-11.		N/A
	The test severity is:		-
	- 750 °C, for connections carrying a current exceeding 0,5 A during normal operation		N/A
	- 650 °C, for other connections		N/A
	Glow-wire applied to an interposed shielding material, if relevant		N/A
	The glow-wire test is not carried out on parts of material classified as having a glow-wire flammability index according to IEC 60695-2-12 of at least:		N/A
	- 750 °C, for connections carrying a current exceeding 0,5 A during normal operation		N/A
	- 650 °C, for other connections		N/A
	The glow-wire test is also not carried out on small parts. These parts are to:		N/A
	- comprise material having a glow-wire flammability index of at least 750 °C, or 650 °C as appropriate, or		N/A
	- comply with the needle-flame test of Annex E, or		N/A

IEC 60335-2-6			
Clause	Requirement + Test	Result - Remark	Verdict
	- comprise material classified as V-0 or V-1 according to IEC 60695-11-10..... :		N/A
	Glow-wire test not applicable to conditions as specified		N/A
30.2.3	Appliances operated while unattended, tested as specified in 30.2.3.1 and 30.2.3.2		P
	Tests not applicable to conditions as specified		N/A
30.2.3.1	Parts of insulating material supporting connections carrying a current exceeding 0.2A during normal operation, and		P
	parts of non-metallic material within a distance of 3mm,		N/A
	subjected to the glow-wire test of IEC 60695-2-11 with a test severity of 850°C		P
	Glow-wire applied to an interposed shielding material, if relevant		N/A
	The glow-wire test is not carried out on parts of material classified as having a glow-wire flammability index according to IEC 60695-2-12 of at least 850 °C		N/A
30.2.3.2	Parts of non-metallic material supporting current-carrying connections, and		P
	parts of non-metallic material within a distance of 3mm,		N/A
	subjected to glow-wire test of IEC 60695-2-11		P
	The test severity is:		N/A
	- 750 °C, for connections carrying a current exceeding 0,2 A during normal operation		P
	- 650 °C, for other connections		N/A
	Glow-wire applied to an interposed shielding material, if relevant		N/A
	However, the glow-wire test of 750 °C or 650 °C as appropriate, is not carried out on parts of material fulfilling both or either of the following classifications:		N/A
	- a glow-wire ignition temperature according to IEC 60695-2-13 of at least:		N/A
	<ul style="list-style-type: none"> • 775 °C, for connections carrying a current exceeding 0,2 A during normal operation 		N/A
	<ul style="list-style-type: none"> • 675 °C, for other connections 		N/A
	- a glow-wire flammability index according to IEC 60695-2-12 of at least:		N/A
	- 750 °C, for connections carrying a current exceeding 0,2 A during normal operation		N/A

IEC 60335-2-6			
Clause	Requirement + Test	Result - Remark	Verdict
	- 650 °C, for other connections		N/A
	The glow-wire test is also not carried out on small parts. These parts are to:		N/A
	- comprise material having a glow-wire ignition temperature of at least 775 °C or 675 °C as appropriate, or		N/A
	- comprise material having a glow-wire flammability index of at least 750 °C or 650 °C as appropriate, or		N/A
	- comply with the needle-flame test of Annex E, or		N/A
	- comprise material classified as V-0 or V-1 according to IEC 60695-11-10		N/A
	The consequential needle-flame test of Annex E applied to non-metallic parts that encroach within the vertical cylinder placed above the centre of the connection zone and on top of the non-metallic parts supporting current-carrying connections, and parts of non-metallic material within a distance of 3 mm of such connections if these parts are those:		N/A
	- parts that withstood the glow-wire test of IEC 60695-2-11 of 750 °C or 650 °C as appropriate, but produce a flame that persist longer than 2 s, or		N/A
	- parts that comprised material having a glow-wire flammability index of at least 750 °C or 650 °C as appropriate, or		N/A
	- small parts, that comprised material having a glow-wire flammability index of at least 750 °C or 650 °C as appropriate, or		N/A
	- small parts for which the needle-flame test of Annex E was applied, or		N/A
	- small parts for which a material classification of V-0 or V-1 was applied		N/A
	However, the consequential needle-flame test is not carried out on non-metallic parts, including small parts, within the cylinder that are:		-
	- parts having a glow-wire ignition temperature of at least 775 °C or 675 °C as appropriate, or		N/A
	- parts comprising material classified as V-0 or V-1 according to IEC 60695-11-10, or		N/A
	- parts shielded by a flame barrier that meets the needle-flame test of Annex E or that comprises material classified as V-0 or V-1 according to IEC 60695-11-10		N/A
30.2.4	Base material of printed circuit boards subjected to needle-flame test of annex E		N/A
	Test not applicable to conditions as specified	V-0	P

31	RESISTANCE TO RUSTING		
----	-----------------------	--	--

IEC 60335-2-6			
Clause	Requirement + Test	Result - Remark	Verdict

	Relevant ferrous parts adequately protected against rusting		P
--	---	--	---

32	RADIATION, TOXICITY AND SIMILAR HAZARDS		
	Appliance shall not emit harmful radiation, present a toxic or similar hazard due to their operation in normal use		P
	Relevant tests specified in part 2, if necessary		N/A
32.101	Pyrolytic self-cleaning ovens shall be constructed so that the carbon monoxide is not discharged in hazardous quantities during cleaning (IEC 60335-2-6:2002)		N/A

A	ANNEX A (INFORMATIVE) ROUTINE TESTS		
	Description of routine tests to be carried out by the manufacturer	See CIG023 report	P

B	ANNEX B (NORMATIVE) APPLIANCES POWERED BY RECHARGEABLE BATTERIES		
	The following modifications to this standard are applicable for appliances powered by batteries that are recharged in the appliance		N/A
	This annex does not apply to battery chargers		N/A
3.1.9	Appliance operated under the following conditions:		N/A
	-the appliance, supplied by its fully charged battery, operated as specified in relevant part 2		N/A
	-the battery is charged, the battery being initially discharged to such an extent that the appliance cannot operate		N/A
	-if possible, the appliance is supplied from the supply mains through its battery charger, the battery being initially discharged to such an extent that the appliance cannot operate. The appliance is operated as specified in relevant part 2		N/A
	If the appliance incorporates inductive coupling between two parts that are detachable from each other, the appliance is supplied from the supply mains with the detachable part removed		N/A
3.6.2	Part to be removed in order to discard the battery is not considered to be detachable		N/A

IEC 60335-2-6			
Clause	Requirement + Test	Result - Remark	Verdict
5.101	Appliances supplied from the supply mains tested as specified for motor-operated appliances		N/A
7.1	Battery compartment for batteries intended to be replaced by the user, marked with battery voltage and polarity of the terminals		N/A
7.12	The instructions for appliances incorporating batteries intended to be replaced by the user includes required information		N/A
	Details about how to remove batteries containing materials hazardous to the environment given		N/A
7.15	Markings placed on the part of the appliance connected to the supply mains		N/A
8.2	Appliances having batteries that according to the instruction may be replaced by the user need only have basic insulation between live parts and the inner surface of the battery compartment		N/A
	If the appliance can be operated without batteries, double or reinforced insulation required		N/A
11.7	The battery is charged for the period described		N/A
19.1	Appliances subjected to tests of 19.101, 19.102 and 19.103		N/A
19.101	Appliances supplied at rated voltage for 168 h, the battery being continually charged		N/A
19.102	Short-circuiting of the terminals of the battery, being fully charged, for appliances having batteries that can be removed without the aid of a tool		N/A
19.103	Appliances having batteries replaceable by the user supplied at rated voltage under normal operation with the battery removed or in any position allowed by the construction		N/A
21.101	Appliances having pins for insertion into socket-outlets have adequate mechanical strength, checked according to procedure 2 of IEC 68-2-32		N/A
	Part of the appliance incorporating the pins subjected to the free fall test, procedure 2, of IEC 60068-2-32, the number of falls being:		-
	- 100, the mass of part does not exceed 250 g		N/A
	- 50, the mass of part exceeds 250 g		N/A
	After the test, the requirements of 8.1, 15.1.1, 16.3 and clause 29 are met		N/A
22.3	Appliances having pins for insertion into socket-outlets tested as fully assembled as possible		N/A

IEC 60335-2-6			
Clause	Requirement + Test	Result - Remark	Verdict
25.13	An additional lining or bushing not required for interconnection cords operating at safety extra-low voltage		N/A
30.2	For parts of the appliance connected to the supply mains during the charging period, 30.2.3 applies		N/A
	For other parts, 30.2.2 applies		N/A
C	ANNEX C (NORMATIVE) AGEING TEST ON MOTORS		
	Tests, as described, carried out when doubt with regard to the temperature classification of the insulation of a motor winding		N/A
D	ANNEX D (NORMATIVE) THERMAL MOTOR PROTECTORS		
	Applicable to appliances having motors that incorporate thermal motor protectors		N/A
E	ANNEX E (NORMATIVE) NEEDLE-FLAME TEST		
	Needle-flame test carried out in accordance with IEC 60695-11-5, with the following modifications:		N/A
7	Severities		-
	The duration of application of the test flame is 30 s ± 1 s		N/A
9	Test procedure		-
9.1	The specimen so arranged that the flame can be applied to a vertical or horizontal edge as shown in the examples of figure 1		N/A
9.2	The first paragraph does not apply		N/A
	If possible, the flame is applied at least 10 mm from a corner		N/A
9.3	The test is carried out on one specimen		N/A
	If the specimen does not withstand the test, the test may be repeated on two additional specimens, both withstanding the test		N/A
10	Evaluation of test results		-
	The duration of burning not exceeding 30 s		N/A
	However, for printed circuit boards, the duration of burning not exceeding 15 s		N/A

IEC 60335-2-6			
Clause	Requirement + Test	Result - Remark	Verdict
F	ANNEX F (NORMATIVE) CAPACITORS		
	Capacitors likely to be permanently subjected to the supply voltage, and used for radio interference suppression or voltage dividing, comply with the following clauses of IEC 60384-14, with the following modifications:		N/A
1.5	Terminology		-
1.5.3	Class X capacitors tested according to subclass X2		N/A
1.5.4	This subclause is applicable		N/A
1.6	Marking		-
	Items a) and b) are applicable		N/A
3.4	Approval testing		-
3.4.3.2	Table II is applicable as described		N/A
4.1	Visual examination and check of dimensions		-
	This subclause is applicable		N/A
4.2	Electrical tests		-
4.2.1	This subclause is applicable		N/A
4.2.5	This subclause is applicable		N/A
4.2.5.2	Only table IX is applicable		N/A
	Values for test A apply		N/A
	However, for capacitors in heating appliances the values for test B or C apply		N/A
4.12	Damp heat, steady state		-
	This subclause is applicable		N/A
	Only insulation resistance and voltage proof are checked		N/A
4.13	Impulse voltage		-
	This subclause is applicable		N/A
4.14	Endurance		-
	Subclauses 4.14.1, 4.14.3, 4.14.4 and 4.14.7 applicable		N/A
4.14.7	Only insulation resistance and voltage proof are checked		N/A
	Visual examination, no visible damage		N/A
4.17	Passive flammability test		-

IEC 60335-2-6			
Clause	Requirement + Test	Result - Remark	Verdict
	This subclause is applicable		N/A
4.18	Active flammability test		-
	This subclause is applicable		N/A

G			
ANNEX G (NORMATIVE) SAFETY ISOLATING TRANSFORMERS			
	The following modifications to this standard are applicable for safety isolating transformers:		N/A
7	Marking and instructions		-
7.1	Transformers for specific use marked with:		-
	-name, trademark or identification mark of the manufacturer or responsible vendor		N/A
	-model or type reference		N/A
17	Overload protection of transformers and associated circuits		-
	Fail-safe transformers comply with subclause 15.5 of IEC 61558-1		N/A
22	Construction		-
	Subclauses 19.1 and 19.1.2 of IEC 61558-2-6 are applicable		N/A
29	Clearances, creepage distances and solid insulation		-
29.1, 29.2 and 29.3	The distances specified in items 2a, 2c and 3 in table 13 of IEC 61558-1 apply		N/A

H			
ANNEX H (NORMATIVE) SWITCHES			
	Switches comply with the following clauses of IEC 61058-1, as modified:		-
	-The tests of IEC 61058-1 carried out under the conditions occurring in the appliance		N/A
	-Before being tested, switches are operated 20 times without load		N/A
8	Marking and documentation		-
	Switches are not required to be marked		N/A
	However, switches that can be tested separately from the appliance marked with the manufacturer's name or trade mark and the type reference		N/A
13	Mechanism		-
	The tests may be carried out on a separate sample		N/A
15	Insulation resistance and dielectric strength		-

IEC 60335-2-6			
Clause	Requirement + Test	Result - Remark	Verdict
15.1	Not applicable		N/A
15.2	Not applicable		N/A
15.3	Applicable for full disconnection and micro-disconnection		N/A
17	Endurance		-
	Compliance is checked on three separate appliances or switches		N/A
	For 17.2.4.4, the number of cycles is 10 000, unless otherwise specified in 24.1.3 of the relevant part 2 of IEC 60335		N/A
	Switches for operation under no load and which can be operated only by a tool and switches operated by hand that are interlocked so that they cannot be operated under load, are not subjected to the tests		N/A
	Subclauses 17.2.2 and 17.2.5.2 not applicable		N/A
	The ambient temperature during the test is that occurring in the appliance during the test of Clause 11 in IEC 60335-1		N/A
	Temperature rise of the terminals not more than 30 K above the temperature rise measured in clause 11 of IEC 60335-1		N/A
20	Clearances, creepage distances, solid insulation and coatings of rigid printed board assemblies		-
	This clause is applicable to clearances and creepage distances for functional insulation, across full disconnection and micro-disconnection, as stated in table 24		N/A

I	ANNEX I (NORMATIVE) MOTORS HAVING BASIC INSULATION THAT IS INADEQUATE FOR THE RATED VOLTAGE OF THE APPLIANCE		
	The following modifications to this standard are applicable for motors having basic insulation that is inadequate for the rated voltage of the appliance:		N/A
8	Protection against access to live parts		-
8.1	Metal parts of the motor are considered to be bare live parts		N/A
11	Heating		-
11.3	Temperature rise of the body of the motor is determined instead of the temperature rise of the windings		N/A

IEC 60335-2-6			
Clause	Requirement + Test	Result - Remark	Verdict
11.8	Temperature rise of the body of the motor, where in contact with insulating material, not exceeding values in table 3 for the relevant insulating material		N/A
16	Leakage current and electric strength		-
16.3	Insulation between live parts of the motor and its other metal parts not subjected to the test		N/A
19	Abnormal operation		
19.1	The tests of 19.7 to 19.9 not carried out		N/A
19.101	Appliance operated at rated voltage with each of the following fault conditions:		-
	- short circuit of the terminals of the motor, including any capacitor incorporated in the motor circuit		N/A
	- short circuit of each diode of the rectifier		N/A
	- open circuit of the supply to the motor		N/A
	- open circuit of any parallel resistor, the motor being in operation		N/A
	Only one fault simulated at a time, the tests carried out consecutively		N/A
22	Construction		-
22.101	For class I appliances incorporating a motor supplied by a rectifier circuit, the d.c. circuit being insulated from accessible parts of the appliance by double or reinforced insulation		N/A
	Compliance checked by the tests specified for double and reinforced insulation		N/A

J	ANNEX J (NORMATIVE) COATED PRINTED CIRCUIT BOARDS		
	Testing of protective coatings of printed circuit boards carried out in accordance with IEC 60664-3 with the following modifications:		N/A
5.7	Conditioning of the test specimens		-
	When production samples are used, three samples of the printed circuit board are tested		N/A
5.7.1	Cold		-
	The test is carried out at -25°C		N/A
5.7.3	Rapid change of temperature		-
	Severity 1 is specified		N/A
5.9	Additional tests		-
	This subclause is not applicable		N/A

IEC 60335-2-6			
Clause	Requirement + Test	Result - Remark	Verdict

K	ANNEX K (NORMATIVE) OVERVOLTAGE CATEGORIES		
	The information on overvoltage categories is extracted from IEC 60664-1		P
	Overvoltage category is a numeral defining a transient overvoltage condition		P
	Equipment of overvoltage category IV is for use at the origin of the installation		N/A
	Equipment of overvoltage category III is equipment in fixed installations and for cases where the reliability and the availability of the equipment is subject to special requirements		N/A
	Equipment of overvoltage category II is energy consuming equipment to be supplied from the fixed installation		P
	If such equipment is subjected to special requirements with regard to reliability and availability, overvoltage category III applies		N/A
	Equipment of overvoltage category I is equipment for connection to circuits in which measures are taken to limit transient overvoltages to an appropriate low level		N/A

L	ANNEX L (INFORMATIVE) GUIDANCE FOR THE MEASUREMENT OF CLEARANCES AND CREEPAGE DISTANCES		
	Sequences for the determination of clearances and creepage distances		P

M	ANNEX M (NORMATIVE) POLLUTION DEGREE		
	The information on pollution degrees is extracted from IEC 60664-1		P
	Pollution		-
	The microenvironment determines the effect of pollution on the insulation, taking into account the macroenvironment		P
	Means may be provided to reduce pollution at the insulation by effective enclosures or similar		P
	Minimum clearances specified where pollution may be present in the microenvironment		P
	Degrees of pollution in the microenvironment		-

IEC 60335-2-6			
Clause	Requirement + Test	Result - Remark	Verdict

	For evaluating creepage distances, the following degrees of pollution in the microenvironment are established:		-
	- pollution degree 1: no pollution or only dry, non-conductive pollution occurs. The pollution has no influence		N/A
	- pollution degree 2: only non-conductive pollution occurs, except that occasionally a temporary conductivity caused by condensation is to be expected		P
	- pollution degree 3: conductive pollution occurs or dry non-conductive pollution occurs that becomes conductive due to condensation that is to be expected		N/A
	- pollution degree 4: the pollution generates persistent conductivity caused by conductive dust or by rain or snow		N/A

N	ANNEX N (NORMATIVE) PROOF TRACKING TEST		
	The proof tracking test is carried out in accordance with IEC 60112 with the following modifications:		N/A
7	Test apparatus		-
7.3	Test solutions		-
	Test solution A is used		N/A
10	Determination of proof tracking index (PTI)		-
10.1	Procedure		-
	The proof voltage is 100V, 250V, 175V, 400V or 600V		N/A
	The last paragraph of Clause 3 applies		N/A
	The test is carried out on five specimens		N/A
	In case of doubt, additional test with proof voltage reduced by 25V, the number of drops increased to 100		N/A
10.2	Report		-
	The report stating if the PTI value was based on a test using 100 drops with a test voltage of (PTI-25) V		N/A

O	ANNEX O (INFORMATIVE) SELECTION AND SEQUENCE OF THE TESTS OF CLAUSE 30		
	Description of tests for determination of resistance to heat and fire		N/A

IEC 60335-2-6			
Clause	Requirement + Test	Result - Remark	Verdict
P	ANNEX P (INFORMATIVE) GUIDANCE FOR THE APPLICATION OF THIS STANDARD TO APPLIANCES USED IN WARM DAMP EQUABLE CLIMATES		
	Modifications applicable for class 0 and 01 appliances having a rated voltage exceeding 150V, intended to be used in countries having a warm damp equable climate and that are marked WDaE		-
	Modifications may also be applied to class 1 appliances having a rated voltage exceeding 150V, intended to be used in countries having a warm damp equable climate and that are marked WdaE, if liable to be connected to a supply mains that excludes the protective earthing conductor		-
5	General conditions for the tests		-
5.7	The ambient temperature for the tests of Clauses 11 and 13 is 40 ⁺³ / ₀		N/A
7	Marking and instructions		-
7.1	The appliance marked with the letters WDaE		N/A
7.12	The instructions state that the appliance is to be supplied through a RCD having a rated residual operating current not exceeding 30 mA		N/A
	The instructions state that the appliance is considered to be suitable for use in countries having a warm damp equable climate, but may also be used in other countries		N/A
11	Heating		-
11.8	The values of Table 3 are reduced by 15 K		N/A
13	Leakage current and electric strength at operating temperature		-
13.2	The leakage current for class I appliances not exceeding 0,5 mA		N/A
15	Moisture resistance		-
15.3	The value of t is 37 °C		N/A
16	Leakage current and electric strength		-
16.2	The leakage current for class I appliances not exceeding 0,5 mA		N/A
19	Abnormal operation		-
19.13	The leakage current test of 16.2 is applied in addition to the electric strength test of 16.3		N/A
Q	ANNEX Q (INFORMATIVE) SEQUENCE OF TESTS FOR THE EVALUATION OF ELECTRONIC CIRCUITS		
	Description of tests for appliances incorporating electronic circuits		-

IEC 60335-2-6			
Clause	Requirement + Test	Result - Remark	Verdict

R	ANNEX R (NORMATIVE) SOFTWARE EVALUATION		
	Software evaluated in accordance with the following clauses of Annex H of IEC 60730-1, as modified		-

H.2	Definitions		-
	Only definitions H.2.16 to H.2.20 applicable		N/A
H.7	Information		-
	Only footnotes 12) to 18) of Table 7.2, as modified, applicable		N/A
H.11.12	Controls using software		-
	All the subclauses of H.11.12, as modified, except H.11.12.6 and H.11.12.6.1, applicable		N/A
H.11.12.7	Delete text		N/A
H.11.12.7.1	For appliances using software class C having a single channel with self-test and monitoring structure, the manufacturer provides the measures necessary to address the fault/errors in safety related segments and data		N/A
H.11.12.8	Software fault/error detection occurs before compliance with 19.13 of IEC 60335-1 is impaired		N/A
H.11.12.8.1	Replace text		N/A
H.11.12.13	Software and safety related hardware under its control initializes and terminates before compliance with 19.13 of IEC 60335-1 is impaired		N/A

IEC 60335-2-6

10.1	TABLE: Power input deviation					P
Input deviation of/at:	P rated (W)	P measured (W)	dP	Required dP	Remark	
230V						
Hob elements of 1000W	1000	1000	0%	+5%/-10%	P	
Hob elements of 1200W	1200	1175-1238	-2,1%/+3,2%	+5%/-10%	P	
Hob elements of 1700W	1700	1695-1755	-0,3%/+3,24%	+5%/-10%	P	
Hob elements of 1800W	1800	1800-1858	0%/+3,22%	+5%/-10%	P	
Hob elements of 2000W	2000	2000	0%	+5%/-10%	P	
Hob elements of 2100W	2100	2060-2133	-1,9%/+1,57%	+5%/-10%	P	
Hob elements of 2200W	2200	2205-2220	+0,2%/+0,9%	+5%/-10%	P	
Hob elements of 2400W	2400	2385	-0,6%	+5%/-10%	P	
Hob element 700/2000W	700/2000	700/2040	0%/+2%	+5%/-10%	P	
Hob element 1400/2200W	1400/2200	1410/2190	0.7%/-0.45%	+5%/-10%	P	
Hob element 600W	600	600	0%	+5%/-10%	P	
Total	Various	Various	(*)	+5%/-10%	P	
P58 EO6200 (230V)	6200	6100	-1,6%	+5% / -10%	P	
230V (EC6700)	6700	6600	-1,5%	+5%/-10%	P	
230V (EC5500)	5500	5580	+1,5%	+5%/-10%	P	
P58 EO6900 (230V)	6900	6780	-1,74%	+5% / -10%	P	
Hob element EIKA res.	2300	2280	-0,9%	+5%/-10%	P	
Hob element EGO res.	2300	2280	-0,9%	+5%/-10%	P	
Hob element, 1700/700W	1700/700	1670/684	-1,8%/-2,3%	+5%/-10%	Double Zone E.G.O 10.58213.004	

*) : As long as each of the hob elements separately are within the limits of +5%/-10%, then the various combinations of hob elements being used for the different types will also be within the limit.

10.2	TABLE: Current deviation					N/A
Current deviation of/at:	I rated (A)	I measured (A)	dI	Required dI	Remark	

IEC 60335-2-6

11.7	TABLE: heating temperature specifications			P
test step n°/ function	temperature	duration	Model	
1. Hob	-	60 min	EO6800 w. eika	
2.Hob	-	60 min	EO6800 w. DIEHL	
3. Hob	-	60 min	RV6300	
4. Hob	-	60 min	EV6200	
5. Hob	-	60 min	EO6200	
6.Hob	-	60 min	EO6400	
7.Hob	-	60 min	MV5900	
8.Hob	-	60 min	EO6800 w. EGO	
9.Hob	-	60 min	EO5400 w. DIEHL	
10.Hob	-	60 min	EO6700 w. DIEHL	
11.Hob	-	60 min	EO6200 w. eika	
12.Hob	-	60 min	EC6700 w. eika	
13.Hob	-	60 min	EC5500 w. eika	
14.Hob	-	60 min	EO6900 w. eika	
15.Hob	-	60 min	EC6700 w. eika	
16.Hob	-	60 min	EC5400 w. eika	
17.Hob	-	60 min	EO6400 w. eika	

IEC 60335-2-6

11.8 (1.)	TABLE: Heating test, thermocouples	P
	TYPE P58..... MODEL EO6800 with EIKA electronic board 8A 1..0 360..... or 8B.1..0 360.....	
	Test voltage (V)	258V (8515W) —
	Ambient (°C)	23.5 —
Thermocouple locations	dT (K)	Max. dT (K)
Supply cord	18	50
Terminal block	30	60
Internal wires (glass fibre) near 2200W element (T180)	94	155
Thermostat body (T250)	107	225
Printed circuit board	43	Cfr.cl.30
Bottom plate of the appliance, against the floor of the test corner	70	-
Test corner floor, 25mm below bottom plate of the appliance	25	70
Built-in frame	61	70
Test corner walls	19	70
Transformer cover	60	Cfr.cl.30
Touch control (Touched only for short period during normal use)	22	45
Relay cover	56	Cfr.cl.30

IEC 60335-2-6

(2.)	TYPE P58..... MODEL EO6800 with DIEHL electronic board TC-4SE-Z-XX-YY-105-U230		
	Test voltage (V)	258V (8515W)	—
	Ambient (°C)	23.7	—
Thermocouple locations		dT (K)	Max. dT (K)
Supply cord		19	50
Terminal block		33	60
Internal wires (glass fibre) near 2200W element (T180)		98	155
Thermostat body (T250)		112	225
Printed circuit board		59	Cfr.cl.30
Bottom plate of the appliance, against the floor of the test corner		73	-
Test corner floor, 25mm below bottom plate of the appliance		29	70
Built-in frame		63	70
Test corner walls		23	70
Plastic parts of transformer		50	Cfr.cl.30
Touch control (Touched only for short period during normal use)		38	45
Relay cover		56	Cfr.cl.30
03100 Coil winding (Class E)		57	80
X2 0.1µF capacitor T110		56	85

IEC 60335-2-6

(3.)	TYPE P58..... MODEL RV6300		
	Test voltage (V)	256.7V (7889W)	—
	Ambient (°C)	23.5	—
Thermocouple locations		dT (K)	Max. dT (K)
Supply cord		40	50
Terminal block		59	60/85/115
Internal wires (glass fibre) near 1800W element (T180)		90	155
Internal wires (glass fibre) PCB (T180)		80	155
Internal wires (glass fibre) near 2100W element (T180)		110	155
Thermostat body (T250)		202	225
Energy regulator, MSA-V01, T125		118	Cfr. cl. 30**
Energy regulator, MSA-V03, T125		115	Cfr. cl. 30**
Energy regulator, MSA 369-TW, T125		123	Cfr. cl. 30**
Printed circuit board, T105		72	80
Lamps on PCB		63	Cfr.cl.30
Knob		25	45
Bottom plate of the appliance, against the floor of the test corner		70	-
Test corner floor, 25mm below bottom plate of the appliance		25	70
Built-in frame LF		70	70
Built-in frame RF		70	70
Built-in frame RB		65	70
Test corner walls		24	70
**) the component exceeds the T-marking. It was tested for cl.30 for the conditions occurring in the appliance.			

IEC 60335-2-6

(4.)	TYPE P58..... MODEL EV6200		
	Test voltage (V)	255.8V (7763W)	—
	Ambient (°C)	23.5	—
Thermocouple locations		dT (K)	Max. dT (K)
Supply cord		31	50
Terminal block		40	60/85/115
Internal wires (glass fibre) near 1700W element (T180)		90	155
Internal wires PCB 90°C		58	65
Internal wires (glass fibre) near 2100W element (T180)		110	155
Thermostat body T250°C		202	225
Transformer Enclosure		78	Cfr. cl. 30
Relay cover		58	Cfr. cl. 30
Printed circuit board, T130		67	105
Surface of touch control area		25	45
Bottom plate of the appliance, against the floor of the test corner		94	
Test corner floor		25	70
Built-in frame LF		70	70
Built-in frame LB		65	70
Test corner walls		24	70

IEC 60335-2-6

(5.)	TYPE P58..... MODEL EO6200		
	Test voltage (V)	255.8V (7763W)	—
	Ambient (°C)	22.5	—
Thermocouple locations		dT (K)	Max. dT (K)
Supply cord		40	50
Terminal block, KADO 2/5		72	Cfr. cl. 30
Internal wires (glass fibre) near 1700W element (T180)		79	155
Internal wires (glass fibre) near 2100W element (T180)		140	155
Thermostat body T250°C		202	225
Transformer, STEGER Enclosure		63	Cfr. cl. 30
Transformer, BOBINADOS t _a 105		60	80
Relay NAIS cover		57	Cfr. cl. 30
Relay Schrack cover		48	Cfr. cl. 30
Printed circuit board,		44	Cfr. cl. 30
Surface of touch control area		25	45
Bottom plate of the appliance, against the floor of the test corner		84	-
Test corner floor		25	70
Built-in frame LB		60	70
Built-in frame RB		58	70
Test corner walls		24	70

IEC 60335-2-6

(6.)	TYPE P58..... MODEL EO6400		
	Test voltage (V)	259V (7950W)	—
	Ambient (°C)	25.0	—
	Thermocouple locations	dT (K)	Max. dT (K)
	Wood frame Right – rear element	23	70
	Wood frame Right – front element	11	70
	Wood frame Left – rear element	23	70
	Wood frame Left – front element	30	70
	Wood frame Front – right element	17	70
	Wood frame Front – left element	35	70
	Wood frame Rear – right element	39	70
	Wood frame Rear – left element	41	70
	Trafo Surface t_a 70	43	45
	Test corner walls	17	70

IEC 60335-2-6

(7.)	TYPE P58..... MODEL MV5900		
	Test voltage (V)	255.7V (7388W)	—
	Ambient (°C)	24.0	—
Thermocouple locations		dT (K)	Max. dT (K)
Supply cord		40	50
Terminal block		59	60/85/115
Internal wires (glass fibre) near 1800W element (T180)		90	155
Internal wires (glass fibre) PCB (T180)		80	155
Thermostat body T250°C		202	225
Energy regulator, MSA-V01, T125		95	100
Energy regulator, MSA-312-TW, T125		116	Cfr. cl. 30**
Energy regulator, MSA-369-TW, T125		121	Cfr. cl. 30**
Energy regulator, MSA-V03, T125		95	100
Energy regulator, EGO, T125		84	100
Switches, EGO, 41.41723.005, T140		95	115
Printed circuit board, T105		72	80
Lamps on PCB		63	cfr. §30
Knob		25	45
Bottom plate of the appliance, against the floor of the test corner		70	70
Test corner floor		34	70
Built-in frame LF		70	70
Built-in frame RB		61	70
Test corner walls		31	70
**) The component exceed the T-marking. It was tested for cl. 30 for the conditions occurring in the appliance.			

IEC 60335-2-6

(8.)	TYPE P58..... MODEL EO6800 with EGO electronic board 75.13061.201 (4 relays) or 75.13061.202 (5 relays)		
	Test voltage (V)	258V (8515W)	—
	Ambient (°C)	22.0	—
Thermocouple locations		dT (K)	Max. dT (K)
PCB		65	Cfr.cl.30
Relay Tyco Schrack LNA333012-01 windings		59	Considered as class 105(A) 65
Plastic parts of transformer ERA UI30/..		69	Cfr.cl.30

(9.)	TYPE P58..... MODEL EO5400 with DIEHL electronic board TC3-Q-9T-4R-U230		
	Test voltage (V)	258V (8515W)	—
	Ambient (°C)	22.0	—
Thermocouple locations		dT (K)	Max. dT (K)
Finder relay type 45.71.7.006.0310		55	Considered as class 105(A) 65
Relay NAIS JS1a-B-6V-F-H150		60	Considered as class 105(A) 65
PCB		57	Cfr.cl.30
Coil Tokin 03100 Class E		74	80
Plastic parts of transformer Kaschke 063.682		64	Cfr.cl.30
X2 BC capacitor T105		67	80

IEC 60335-2-6

(10.)	TYPE P58..... MODEL EO6700 with DIEHL electronic board TC4 Standard H		
	Test voltage (V)	261V (8390W)	—
	Ambient (°C)	20.0	—
Thermocouple locations	dT (K)	Max. dT (K)	
PCB	63	Cfr.cl.30	
X2 Capacitor T110	47	85	
Plastic part of trafo Kaschke 451 761	51	Cfr.cl.30	
Coil 03100 Class E windings	69	95	
Fast on cover	74	Cfr.cl.30	
Relay Tyco Schrack LNH33006 enclosure	57	Cfr.cl.30	
Relay Tyco Schrack RFH34006 enclosure	52	Cfr.cl.30	
Glass ceramic of touch control	25	45	

(11.)	TYPE P58..... MODEL EO6200 with EIKA electronic board BJ3xxA36211101		
	Test voltage (V)	261V (7,76kW)	—
	Ambient (°C)	22	—
Thermocouple locations	dT (K)	Max. dT (K)	
Supply cord (T90)	31	65	
X2 capacitor (T110)	38	85	
Transformer	36	65	
Relay (LNH33012) #1	37	65	
Relay (LNH33012) #2	39	65	
PCB	38	120	
Test enclosure	39	65	

IEC 60335-2-6

11.8 (12.)	TABLE: Heating test, thermocouples	P
	TYPE P58..... MODEL EC6700 with new PCB control unit PCB control unit: EIKA _ BG361336011103	
	Test voltage (V)	260V (8,39kW) —
	Ambient (°C)	22,5 —
Thermocouple locations	dT (K)	Max. dT (K)
Supply cord (T90)	48	65
X2 capacitor (T110)	47	85
Transformer	50	65
Relay (LNH33012) 1	58	65
Relay (LNH33012) 2	59	65
PCB	59	120

(13.)	TYPE P58..... MODEL EC5500 with new PCB control unit and new heating element PCB control unit: EIKA _ BG341336011109 Heating element: EGO _ 10.53211.004 / EIKA _ 2502333912	
	Test voltage (V)	257V (6,89kW) —
	Ambient (°C)	23,5 —
Thermocouple locations	dT (K) EGO / EIKA	Max. dT (K)
Supply cord (T90)	39 / 39	65
X2 capacitor (T110)	36 / 37	85
Transformer	38 / 39	65
Relay (LNH33012)	48 / 50	65
PCB	36 / 38	120
Internal wire	100 / 116	175
Test corner, under side place	18 / 17	65
Bottom metal plate	53 / 53	Ref. only

IEC 60335-2-6

(14.)	TYPE P58..... MODEL EO6900 with new PCB control unit and new heating element PCB control unit: EIKA _ BH3715360111xx Heating element: EGO _ 10.51311.xxx / EIKA _ 2302734932		
	Test voltage (V)	261V (8,64kW)	—
	Ambient (°C)	19	—
Thermocouple locations		dT (K)	Max. dT (K)
Supply cord (T90)		63	65
Rast T. Block (T125)		79	100
Thermostat (T250)		123	225
Internal wirings (T200)		109	175
Faston cover (Relay R1)		58	Cfr. Cl.30
Coil relay R1 (cl.155/F)		65	115
Transformer (SMPS, T1)		51	65
PCB		58	120
X2 capacitor (T110)		53	85
Plastic conduit		93	Cfr. Cl.30
Touch control zone		30	45
Wood in general		53	70

(15.)	TYPE P58..... MODEL EC6700 with new alt. heating element and slim dimension PCB control unit: EIKA _ BH3715360111xx Heating element: EGO _ 10.57413.624		
	Test voltage (V)	262V (8,4kW)	—
	Ambient (°C)	20	—
Thermocouple locations		dT (K)	Max. dT (K)
Supply cord (T90)		53	65
Rast T. Block (T125)		80	100
Internal wirings (T200)		124	175
Wooden frame back		57	70
Wooden frame side		47	70

IEC 60335-2-6

(16.)	TYPE P58..... MODEL EC5400 with slim dimension PCB control unit: EIKA _ BH3715360111xx Heating element: EGO _ 10.52213.044		
	Test voltage (V)	262V (6,77kW)	—
	Ambient (°C)	24	—
Thermocouple locations		dT (K)	Max. dT (K)
Wooden frame back		50	70
Wooden floor		21	70
Wooden frame side		32	70

(17.)	TYPE P58..... MODEL EO6400 with PCB control unit: EIKA _ BN34D36211107		
	Test voltage (V)	262V (8022W)	—
	Ambient (°C)	19	—
Thermocouple locations		dT (K)	Max. dT (K)
Supply cord (3G2,5mm ²) (T90)		50	65
Terminal block		56	65
Relay R3		59	Cfr.cl.30
Capacitor C11 (T105)		51	80
Capacitor C12 (T105)		56	80
Inductor L3		59	80
PCB (T105)		48	80
Internal wire (T200)		98	175
Wooden frame side		35	70
Wooden frame rear		57	70
Wooden bottom plate		23	70

IEC 60335-2-6						
11.8	TABLE: Heating test, resistance method					P
	Test voltage (V)	Various			—	
	Ambient, t ₁ (°C)	See below			—	
	Ambient, t ₂ (°C)	See below			—	
Temperature rise of winding	R ₁ (Ω)	R ₂ (Ω)	dT (K)	Max. dT (K)	Insulation class	
Transformer ZAREL Code: 003179675 00321004 (On EIKA Electronic board) 8A 1..0 360..... or 8B.1..0 360.....						
Primary (t ₁ =23.5 t ₂ =23.5)	830	998	52	115	Class 155(F)	
Secondary (t ₁ =23.5 t ₂ =23.5)	3.690	4.580	62	115	Class 155(F)	
Transformer KASCHKE Code: 451 761 (On DIEHL Electronic board)						
Primary (t ₁ =23.7 t ₂ =23.7)	3.963	4.830	57	75	Class 105(A)	
Secondary (t ₁ =23.7 t ₂ =23.7)	0.101	0.128	69	75	Class 105(A)	
Relay Schrack LNH30012						
Winding (t ₁ =23.5 t ₂ =23.5)	337	405	52	75	Class 105(A)	
Transformer Mencarini TRP 01						
Primary (t ₁ =23,0, t ₂ =23,0)	714,3	903,0	68	95	Class 130(B)	
Secondary (t ₁ =23,0, t ₂ =23,0)	7,42	9,13	59	95	Class 130(B)	
Transformer ERA BV 030-...						
Primary 1 (t ₁ =22,0, t ₂ =22,0)	354,6	420,1	47	95	Class 130(B)	
Primary 2 (t ₁ =22,0, t ₂ =22,0)	354,9	423,3	49	95	Class 130(B)	
Secondary 1 (t ₁ =22,0, t ₂ =22,0)	4,615	5,494	49	95	Class 130(B)	
Secondary 2 (t ₁ =22,0, t ₂ =22,0)	4,611	5,440	46	95	Class 130(B)	
Coil of relay schrack RT31... (t ₁ =23,0, t ₂ =23,0)	364,6	436,8	51	75	Class 105(A)	
Coil of relay Matsushita JS1... (t ₁ =23,0, t ₂ =23,0)	395,8	440,4	29	75	Class 105(A)	
Transformer Marschner FLG30...,						
Primary 1 (t ₁ =22,0, t ₂ =22,0)	310,8	379,4	57	115	Class 155(F)	
Primary 2 (t ₁ =22,0, t ₂ =22,0)	308,0	378,1	58	115	Class 155(F)	
Secondary (t ₁ =22,0, t ₂ =22,0)	5,73	6,92	53	115	Class 155(F)	

IEC 60335-2-6					
Transformer STEGER 08-1120					
Primary (t ₁ =22.5 t ₂ =22.5)	1043	1310	66	115	Class 155(F)
Secondary (t ₁ =22.5 t ₂ =24.0)	3.38	4.144	57	115	Class 155(F)
Relay, NAIS JS1a-B-6V-H150					
Winding (t ₁ =22.5 t ₂ =22.5)	96.6	117.1	55	75	Class 105(A)
Transformer ZAREL 2604					
Primary (t ₁ =25 t ₂ =21.5)	748	927	66	115	Class 155(F)
Secondary (t ₁ =25 t ₂ =21.5)	3.438	4.190	60	115	Class 155(F)
Relay, Schrack LNH30012					
Winding (t ₁ =25 t ₂ =21.5)	340	400	49	75	Class 105(A)
Transformer Avisor EI42/14,5,					
Primary (t ₁ =20,5, t ₂ =21,0)	790,1	932,4	45	95	Class 130(B)
Secondary (t ₁ =20,5, t ₂ =21,0)	2,015	2,376	45	95	Class 130(B)
Coil of Relay OMRON G2RL... (t ₁ =20,5, t ₂ =21,0)					
	361,0	428,3	47	75	Class 105(A)
Coil of Relay Carlo Gavazzi M25... (t ₁ =22,5, t ₂ =23,0)					
	357,6	431,3	52	95	Class 130(B)
Coil of Relay Schrack LNH33006 t ₁ =20,0, t ₂ =20,0)					
	84.01	99.93	48	75	Class 105(A)
Coil of Relay Schrack RFH34006 t ₁ =20,0, t ₂ =20,0)					
	85.99	99.42	40	75	Class 105(A)
Transformer ERA Type UI30/10.5 BV 030-7863 0					
Primary (t ₁ =22,0, t ₂ =22,0)	629.8	813.0	75	115	Class 155(F)
Secondary (t ₁ =22,0, t ₂ =22,0)	3.129	3.967	69	115	Class 155(F)
Transformer Kaschke 063.682					

IEC 60335-2-6

Primary (t ₁ =19,0, t ₂ =21,0)	3.965	5.167	75	95	Class 130(B)
Secondary (t ₁ =19,0, t ₂ =21,0)	0.0284	0.037	73	95	Class 130(B)
Coil of Relay Finder 45.71.7.006.0300 (t ₁ =19,0, t ₂ =21,0)	96.84	126.26	59	115	Class 155(F)

11.101	TABLE: Temperature rise limits for accessible surfaces specifications	N/A
test step n°/ function	temperature	duration

11.101	TABLE: Temperature rise limits for accessible front and side surfaces	N/A
	dT (K)	Max. dT (K)
Front surfaces of oven doors	—	—
Test step n.		—
Ambient (°C)		—
Metal and painted metal		45
Vitreous-enamelled metal		50
Glass and ceramic		60
Plastic having a thickness exceeding 0,3mm		80
Other accessible front and side surfaces (or surfaces above 850 mm)		—
Test step n.		—
Ambient (°C)		—
Metal and painted metal		60
Vitreous-enamelled metal		65
Glass and ceramic		80
Plastic having a thickness exceeding 0,3mm		100

IEC 60335-2-6

13.2	TABLE: Leakage current		P
	Heating appliances: 1.15 x rated input	$P = 1,15 * (240/230)^2 * P_r$	—
	Motor-operated and combined appliances: 1.06 x rated voltage.....		—
Leakage current between		I (mA)	Max. allowed I (mA)
Any pole of supply and accessible metal parts		Max. 1,2	Min. 5,1
Between live parts and each of the vessels		Max. 0,04	0.25

13.3	TABLE: Electric strength		P
Test voltage applied between:		Voltage (V)	Breakdown (Yes/No)
Live parts and accessible metal parts (basic insulation)		1000V	No
Live parts and the vessels connected together		3000V	No
Live parts and non earthed accessible touchable parts (control panel)		3000V	No

14	TABLE: Transient overvoltages					N/A
Clearance between:	CI (mm)	Required CI (mm)	Rated impulse voltage (V)	Impulse test voltage (V)	Flashover (Yes/No)	

16.2	TABLE: Leakage current		P
	Single phase appliances: 1.06 x rated voltage	254,4V	—
	Three phase appliances 1.06 x rated voltage divided by $\sqrt{3}$:	254,4V	—
Leakage current between		I (mA)	Max. allowed I (mA)
Any pole of supply and accessible metal parts		Max. 1,4	Min. 5,1
Between live parts and each of the vessels		Max. 0,1	0.25

16.3	TABLE: Electric strength		P
Test voltage applied between:		Voltage (V)	Breakdown (Yes/No)
Live parts and accessible metal parts (basic insulation)		1250	No
Live parts and the vessels electrically connected together		3000	No
Live parts and non earthed accessible touchable parts (control panel)		3000	No

IEC 60335-2-6

17	TABLE: Overload protection, temperature rise	N/A
Temperature rise of part/at:		dT (K)
		Max. dT (K)

19.7	TABLE: Abnormal operation, locked rotor/moving parts	N/A
Test voltage (V)..... :		—
Ambient, t ₁ (°C)..... :		—
Ambient, t ₂ (°C)..... :		—
Temperature of winding	R ₁ (Ω)	R ₂ (Ω)
		dT (K)
		T (°C)
		Max. T (°C)

19.11	TABLE: Fault conditions	P
Test voltage (V)..... :		240V
Ambient, t ₁ (°C)..... :		20
Ambient, t ₂ (°C)..... :		20

Fault No.	Component	OC / SC	Operating condition	Remarks
1	Electrolytic capacitor C1 (Diehl electronic board TC-4SE-Z-XX-YY-105-U230)	OC SC	Not possible to switch on the appliance	No hazard
2	Electrolytic capacitor C2 (Diehl electronic board TC-4SE-Z-XX-YY-105-U230)	OC SC	Not possible to switch on the appliance	No hazard
3	Electrolytic capacitor C1 (Eika electronic board 8A 1..0 360..... or 8B.1..0 360.....)	OC SC	Not possible to switch on the appliance	No hazard
4	Electrolytic capacitor C2 (Eika electronic board 8A 1..0 360..... or 8B.1..0 360.....)	OC SC	Not possible to switch on the appliance	No hazard
5	Electrolytic capacitor C3 (Eika electronic board 8A 1..0 360..... or 8B.1..0 360.....)	OC SC	Not possible to switch on the appliance	No hazard
6	10nF electrolytic capacitor (Diehl electronic board TC3-Q-9T-4R-U230)	OC SC	Not possible to switch on the appliance	No hazard
7	X2 100nF Capacitor on DIEHL electronic board TC4 Standard H	OC	Not possible to switch on the appliance	No hazard
8	R=33Ω on DIEHL electronic board TC4 Standard H	OC SC	Not possible to switch on the appliance The appliance operates as intended	No hazard

IEC 60335-2-6

9	100nF 400V electrolytic capacitor on DIEHL electronic board TC4 Standard H	OC SC	Not possible to switch on the appliance	No hazard
10	330µF 25V electrolytic capacitor on DIEHL electronic board TC4 Standard H	OC SC	Not possible to switch on the appliance	No hazard

Note : No component to be submitted to fault condition on EGO electronic board 75.13061.201 (4 relays) or 75.13061.202 (5 relays)

19.13	TABLE: Abnormal operation, temperature rise, resistance method.					P
	Test voltage (V)..... :	240/ Various			—	
	Ambient, t1 (°C)	Various			—	
	Ambient, t2 (°C)	Various			—	
	Temperature of winding	R ₁ (Ω)	R ₂ (Ω)	dT (K)	T (°C)	Max. T (°C)
	Transformer STEGER 08-112					
	Primary (t ₁ =22.5 t ₂ =25)	1043	1628	142	167	190
	Secondary (t ₁ =22.5 t ₂ =25)	3.38	5.327	146	171	190
	Relay, JS1a-B-6V-H150					
	Winding (t ₁ =22.5 t ₂ =24.5)	96.6	131.7	91	116	150
	Transformer ZAREL 2604					
	Primary (t ₁ =25 t ₂ =25)	748	1135	134	159	240
	Secondary (t ₁ =25 t ₂ =25)	3.438	5.317	142	167	240
	Relay, LNH30012					
	Winding (t ₁ =25 t ₂ =23.5)	340	428	69	93	150
	Transformer FLG30					
	Primary 1 (t ₁ =22,0, t ₂ =22,5)	310,8	424,4	93	116	190
	Primary 2 (t ₁ =22,0, t ₂ =22,5)	308,0	422,3	95	117	190
	Secondary (t ₁ =22,0, t ₂ =22,5)	5,73	7,75	90	112	190
	Transformer TRP 01					
	Primary (t ₁ =23,0, t ₂ =23,0)	714,3	1084,5	133	156	175
	Secondary (t ₁ =23,0, t ₂ =23,0)	7,42	10,14	94	117	175
	Transformer BV 030-...					
	Primary 1 (t ₁ =22,0, t ₂ =21,0)	354,6	472,5	86	107	175

IEC 60335-2-6					
Primary 2 (t ₁ =22,0, t ₂ =21,0)	354,9	471,3	85	106	175
Secondary 1 (t ₁ =22,0, t ₂ =21,0)	4,615	6,135	85	106	175
Secondary 2 (t ₁ =22,0, t ₂ =21,0)	4,611	6,069	82	103	175
Transformer EI42/14,5					
Primary (t ₁ =20,5, t ₂ =22,0)	790,1	1013,8	71	93	175
Secondary (t ₁ =20,5, t ₂ =22,0)	2,015	2,602	73	95	175
Coil of relay RT31... (t ₁ =23,0, t ₂ =23,0)					
Coil of relay JS1... (t ₁ =23,0, t ₂ =23,0)	395,8	478,7	54	77	150
Coil of relay, S5 100... (t ₁ =22,0, t ₂ =22,5)					
Coil of Relay G2RL... (t ₁ =20,5, t ₂ =22,0)	364,2	458,4	64	86	150
Coil of Relay M25... (t ₁ =22,5, t ₂ =22,5)					
Transformer ZAREL Code: 003179675 00321004 Class F (On EIKA Electronic board) (at 267V)					
Primary (t ₁ =23.5 t ₂ =23.5)	830	1340	159	183	190
Secondary (t ₁ =23.5 t ₂ =23.5)	3.690	5.660	153	177	190
Relay, LNH30012 (supposed as class A) (at 267V)					
Winding (t ₁ =23.5 t ₂ =23.5)	337	430	71	95	150
Transformer KASCHKE Code: 451 761 (supposed as class A) (On DIEHL Electronic board) (at 267V)					
Primary (t ₁ =23.5 t ₂ =23.5)	3.963	5.48	99	123	150
Secondary (t ₁ =23.5 t ₂ =23.5)	0.101	0.137	96	120	150
03100 Coil winding (Class E) (at 268V) (termocouple method used)					
	—	—	—	79	215

IEC 60335-2-6

19.13	TABLE: Abnormal operation, temperature rises	P
Thermocouple locations	dT (K)	Max. dT (K)
Supply cord	113	150
Test corner, floor	79	150
Test corner, built-in frame	123	150
Test corner, walls	146	150
Bottom plate of the appliance, against the floor of the test corner	94	150

24.1	TABLE: Components					P
Object / part No.	Manufacturer/ trademark	Type / model	Technical data	Standard	Mark(s) of conformity	
Supply cord	Various	H05V2V2-F	3 x 2,5mm ²	HD21	<HAR>	
Alt.	Various	H05RR-F	3 x 2,5mm ²	HD22	<HAR>	
Alt.	Various	H05BB-F	3 x 2,5mm ²	HD22	<HAR>	
Terminal (P58EO,EV,RO, RV,MO,MV,CO, CV)	Electro-Terminal	EKL 2 EF	450V~ 6mm ²	IECEN 60998-1 IECEN 60998-2-1	VDE ¹⁾ , N, S, D, FI, IMQ ¹⁾ ,	
Alt. (P58RO,RV,MO ,MV)	Electro-Terminal	BEKL3	450V~ 6mm ²	IECEN 60998-1 IECEN 60998-2-1	VDE, ÖVE, IMQ ¹⁾	
Alt. (P58EO,EV,RO, RV,MO,MV,CO, CV)	Electro-Terminal	KADO 2/5	450V~ 24A 2,5mm ²	IECEN 60998-1 IECEN 60998-2-1	VDE	
Alt. (P58RE,RB,ME, MB, CE,CB)	Electro-Terminal	ESKLG21ST	450V 16°	IECEN 60998-1 IECEN 60998-2-1	VDE	
Alt. (P58RE,RB,ME, MB,CE,CB)	Electro-Terminal	ESKL2	400 V 16° – 6 mm	IECEN 60998-1 IECEN 60998-2-1	VDE	
Alt. (P58RO,RV,MO ,MV)	Metalluk	102	400V 16°	IECEN 60998-1 IECEN 60998-2-1	VDE ¹⁾	
Alt. (P58RO,RV,MO ,MV)	Metalluk	119	400V 16°	IECEN 60998-1 IECEN 60998-2-1	VDE ¹⁾	
Alt. (P58RO,RV,MO ,MV)	Metalluk	137	450V 6mm ²	IECEN 60998-1 IECEN 60998-2-1	VDE ¹⁾	

IEC 60335-2-6					
Alternative terminal	NECTO	AD 030 T	2,5 – 6mm ²	IECEN 60998-1 IECEN 60998-2-1	IMQ
Residual heat lamp	Tecnowind	SVA461A	-	IECEN 60335-1 IECEN 60335-2-6	Tested in appliance
For all the Models					
Heating element front left or back right	Ceramaspeed	120N8-L****# *	600W 230V~ φ100mm HL type	IECEN 60335-1 IECEN 60335-2-6	VDE Tested in the appliance
Heating element front left or back right (a)	EIKA	Q) 12020.....*)	600W 230V~ φ100mm	IECEN 60335-1 IECEN 60335-2-6	VDE Tested in the appliance
For Model E..... / Model R..... / Model M.....					
Heating element front left or back right	Ceramaspeed	200N7-L.....	1800W 230V~ φ180mm HL type	IECEN 60335-1 IECEN 60335-2-6	VDE Tested in the appliance
Alt.	EGO	10.58111.xxx	1800W 230V~ φ180mm HL type	IECEN 60335-1 IECEN 60335-2-6	VDE Tested in appliance
Alt.	Ceramaspeed	200N8L6699D	1800W 230-240V~ φ180mm HL type	IECEN 60335-1 IECEN 60335-2-6	VDE Tested in appliance
Alt.	EIKA	2002032932	1800W 230-240V~ φ180mm HL type	IECEN 60335-1 IECEN 60335-2-6	VDE Tested in appliance
Alt.	Ceramaspeed	190V8L6696D	2200/1400W 230V	IECEN 60335-1 IECEN 60335-2-6	VDE Tested in appliance
Alt.	EIKA	2852433832	2200/1400W 230V	IECEN 60335-1 IECEN 60335-2-6	VDE Tested in appliance
Alt.	EGO	10.57413.xxx	2200/1400W 230V	IECEN 60335-1 IECEN 60335-2-6	VDE Tested in appliance
Alt.	EGO	10.58211.xxx	1800W 230-240V~ φ180mm HL type	IECEN 60335-1 IECEN 60335-2-6	VDE Tested in the appliance
Alt.	Ceramaspeed	200N8L6698D	1800W 230-240V~ φ180mm HL type	IECEN 60335-1 IECEN 60335-2-6	VDE Tested in the appliance
Alt.	EIKA	2002032832	1800W 230-240V~ φ180mm HL type	IECEN 60335-1 IECEN 60335-2-6	VDE Tested in the appliance
Alt.	Ceramaspeed	200H8N8688 D	1700W 230-240V~ φ180mm HAL type	IECEN 60335-1 IECEN 60335-2-6	Tested in the appliance
Alt.	EIKA	2001032832	1700W 230-240V~ φ180mm HAL type	IECEN 60335-1 IECEN 60335-2-6	VDE Tested in the appliance
Alt.	EGO	10.98501.xxx	1800W 230-240V~ φ180mm HAL type	IECEN 60335-1 IECEN 60335-2-6	VDE Tested in the appliance
Alt.	EGO	10.78631.xxx	1700W 230-240V~ φ180mm RM type	IECEN 60335-1 IECEN 60335-2-6	VDE Tested in the appliance

IEC 60335-2-6					
Alt.	EGO	10.88631.xxx	1700W 230-240V~ φ180mm RM type	IECEN 60335-1 IECEN 60335-2-6	Tested in the appliance
Alt.	Ceramaspeed	200N57479LY 20336Y	1700W 230-240V~ φ180mm RM type	IECEN 60335-1 IECEN 60335-2-6	Tested in the appliance
Alt.	EIKA	2000632832	1700W 230-240V~ φ180mm RM type	IECEN 60335-1 IECEN 60335-2-6	VDE Tested in the appliance
Alt.	EIKA	2000632932	1700W 230-240V~ φ180mm RM type	IECEN 60335-1 IECEN 60335-2-6	VDE Tested in the appliance
Alt.	EGO	10.58211.xxx	1700/600W 230V~ φ100/180mm HL type	IECEN 60335-1 IECEN 60335-2-6	VDE Tested in the appliance
Alt.	EGO	10.58211.xxx	1700/750W 230V~ φ120/180mm HL type	IECEN 60335-1 IECEN 60335-2-6	VDE Tested in the appliance
Alt.	Ceramaspeed	200T8L6705D	1700/750W 230V~ φ120/180mm HL type	IECEN 60335-1 IECEN 60335-2-6	VDE Tested in the appliance
Alt.	EGO	10.58213.xxx	1700/700W 230V~ Ø120/180mm	IEC/EN 60335-1 IEC/EN 60335-2-6	Tested in appliance VDE
For Model E..... / Model R..... / Model M..... (Except for models EO5100, EO5200, EO5300 and EO5410)					
Alt. Heating element front left or back right	Ceramaspeed	230T8L6703D	2100/700W 230V~ φ120/210mm HL type	IECEN 60335-1 IECEN 60335-2-6	VDE Tested in the appliance
Alt.	EIKA	2302333932	2100/700W 230V~ φ120/210mm HL type	IECEN 60335-1 IECEN 60335-2-6	VDE Tested in the appliance
Alt.	Ceramaspeed	230T8L5625D	2100/700W 230V~ φ120/180mm HL type	IECEN 60335-1 IECEN 60335-2-6	VDE Tested in the appliance
Alt.	EIKA	2302333832	2100/700W 230V~ φ120/210mm HL type	IECEN 60335-1 IECEN 60335-2-6	VDE Tested in the appliance
Alt.	EGO	10.51211.xxx	2100/700W 230V~ φ120/210mm HL type	IECEN 60335-1 IECEN 60335-2-6	VDE Tested in the appliance
Alt.	Ceramaspeed	230T8L5625D	2200/1000W 230V~ φ140/210mm HL type	IECEN 60335-1 IECEN 60335-2-6	VDE Tested in the appliance
Alt.	EIKA	2312333832	2200/1000W 230V~ φ140/210mm HL type	IECEN 60335-1 IECEN 60335-2-6	VDE Tested in the appliance
Alt.	EGO	10.51211.xxx	2200/1000W 230V~ φ140/210mm HL type	IECEN 60335-1 IECEN 60335-2-6	VDE Tested in the appliance

IEC 60335-2-6					
Alt.	Ceramaspeed	230N8L6701D	2200W 220-240V~ φ210mm HL type	IECEN 60335-1 IECEN 60335-2-6	VDE Tested in the appliance
Alt.	EIKA	2302032932	2200W 220-240V~ φ210mm HL type	IECEN 60335-1 IECEN 60335-2-6	VDE Tested in the appliance
Alt.	EIKA	2302032832	2200W 220-240V~ φ210mm HL type	IECEN 60335-1 IECEN 60335-2-6	VDE Tested in the appliance
Alt.	EGO	10.51111.xxx	2200W 220-240V~ φ210mm HL type	IECEN 60335-1 IECEN 60335-2-6	VDE Tested in the appliance
Alt.	EGO	10.81631.xxx	2100W 230-240V~ φ210mm RM type	IECEN 60335-1 IECEN 60335-2-6	Tested in the appliance
Alt.	EIKA	2300632932	2100W 220-240V~ φ210mm RM type	IECEN 60335-1 IECEN 60335-2-6	VDE Tested in the appliance
Alt.	EIKA	2300632832	2100W 230-240V~ φ210mm RM type	IECEN 60335-1 IECEN 60335-2-6	VDE Tested in the appliance
Alt.	EGO	10.71631.xxx	2100W 230-240V~ φ210mm RM type	IECEN 60335-1 IECEN 60335-2-6	VDE Tested in the appliance
For Model M..... / Model C.....					
Alt. Heating element front left or back right	Ceramaspeed	200M58750L	1700W 230-240V~ φ180mm RT type	IECEN 60335-1 IECEN 60335-2-6	Tested in the appliance
Alt.	EIKA	2000734832	1700W 230-240V~ φ180mm RT type	IECEN 60335-1 IECEN 60335-2-6	VDE Tested in the appliance
Alt.	EGO	10.78431.xxx	1700W 230-240V~ φ180mm RT type	IECEN 60335-1 IECEN 60335-2-6	Tested in the appliance
Alt.	EGO	10.71431.xxx	2100W 230-240V~ φ210mm RT type	IECEN 60335-1 IECEN 60335-2-6	Tested in the appliance
Alt.	EIKA	2300734832	2100W 230-240V~ φ210mm RT type	IECEN 60335-1 IECEN 60335-2-6	VDE Tested in the appliance
Alt.	Ceramaspeed	230M58751L	2100W 220-450V~ φ210mm RT type	IECEN 60335-1 IECEN 60335-2-6	Tested in the appliance
For Model E..... / Model R..... / Model M.....					
Heating element back left or front right	EIKA	1652032832	1000W 230V~ φ145mm HL type	IECEN 60335-1 IECEN 60335-2-6	VDE Tested in the appliance
Alt.	EGO	10.54111.xxx	1000W 230V~ φ145mm HL type	IECEN 60335-1 IECEN 60335-2-6	VDE Tested in the appliance
Alt.	EIKA	1652032832	1000W 230V~ φ145mm HL type	IECEN 60335-1 IECEN 60335-2-6	VDE Tested in the appliance

IEC 60335-2-6					
Alt.	Ceramaspeed	165N7-L.....	1200W 230V~ φ145mm HL type	IECEN 60335-1 IECEN 60335-2-6	VDE Tested in the appliance
Alt.	Ceramaspeed	165N8L6695D	1200W 230V~ φ145mm HL type	IECEN 60335-1 IECEN 60335-2-6	VDE Tested in the appliance
Alt.	EIKA	1652032932	1200W 230V~ φ145mm HL type	IECEN 60335-1 IECEN 60335-2-6	VDE Tested in the appliance
Alt.	EIKA	1652032832	1200W 230V~ φ145mm HL type	IECEN 60335-1 IECEN 60335-2-6	VDE Tested in the appliance
Alt.	Ceramaspeed	165N8L6694D	1200W 230V~ φ145mm HL type	IECEN 60335-1 IECEN 60335-2-6	VDE Tested in the appliance
Alt.	EGO	10.54111.xxx	1200W 230V~ φ145mm HL type	IECEN 60335-1 IECEN 60335-2-6	VDE Tested in the appliance
Alt.	Ceramaspeed	165H8N8687 D	1200W 230V~ φ145mm HAL type	IECEN 60335-1 IECEN 60335-2-6	VDE Tested in the appliance
Alt.	EIKA	1651032832	1200W 230V~ φ145mm HAL type	IECEN 60335-1 IECEN 60335-2-6	VDE Tested in the appliance
Alt.	EGO	10.94501.xxx	1200W 230V~ φ145mm HAL type	IECEN 60335-1 IECEN 60335-2-6	VDE Tested in the appliance
Alt.	EIKA	1650632932	1200W 230V~ φ145mm RM type	IECEN 60335-1 IECEN 60335-2-6	VDE Tested in the appliance
Alt.	EIKA	1650632832	1200W 230V~ φ145mm RM type	IECEN 60335-1 IECEN 60335-2-6	VDE Tested in the appliance
Alt.	EGO	10.74631.xxx	1200W 230V~ φ145mm RM type	IECEN 60335-1 IECEN 60335-2-6	VDE Tested in the appliance
Alt. heating element hob 2	E.G.O.	930REHL146 0000 (10.54114.xxx)	230V ~ 1200W Ø 145mm	IECEN 60335-1 IECEN 60335-2-6	Tested in appliance VDE
For Model M..... / Model C.....					
Heating element back left or front right (a)	Ceramaspeed	165M58749L	1200W 230V~ φ145mm RT type	IECEN 60335-1 IECEN 60335-2-6	Tested in the appliance
Heating element back left or front right (a)	EIKA	1650734832	1200W 230V~ φ145mm RT type	IECEN 60335-1 IECEN 60335-2-6	VDE Tested in the appliance
Heating element back left or front right (a)	EGO	10.74431.xxx	1200W 230V~ φ145mm RT type	IECEN 60335-1 IECEN 60335-2-6	Tested in the appliance
Alt. heating element hob 2	E.G.O.	930REHL146 0000 (10.54114.xxx)	230V ~ 1200W Ø 145mm	IECEN 60335-1 IECEN 60335-2-6	Tested in appliance VDE

IEC 60335-2-6					
For Model E..... / R..... / Model M..... (Except for Models EO5100, EO5200, EO5300 and EO5410)					
Heating element back left (a)	EGO	10.57411.xxx	1800/1000W 230V~ φ145/250mm HL type	IECEN 60335-1 IECEN 60335-2-6	VDE Tested in the appliance
Alt.	Ceramaspeed	165V8L6831D	1800/1000W 230V~ φ145/250mm HL type	IECEN 60335-1 IECEN 60335-2-6	VDE Tested in the appliance
Alt.	EIKA	2702433832	1800/1000W 230V~ φ145/250mm HL type	IECEN 60335-1 IECEN 60335-2-6	VDE Tested in the appliance
Alt.	EGO	10.57411.xxx	1800/1000W 230V~ φ145/250mm HL type	IECEN 60335-1 IECEN 60335-2-6	VDE Tested in the appliance
For Model RE.... / RB....					
Heating element back left (a)	Ceramaspeed	190V8L6696D	2200/1400W 230V~ φ170/265mm HL type	IECEN 60335-1 IECEN 60335-2-6	VDE Tested in appliance
Alt.	Ceramaspeed	190V8L6696D	2200/1400W 230V~ φ170/265mm HL type	IECEN 60335-1 IECEN 60335-2-6	VDE Tested in appliance
Alt.	EIKA	2852433832	2200/1400W 230V~ φ170/265mm HL type	IECEN 60335-1 IECEN 60335-2-6	VDE Tested in appliance
Alt.	EGO	10.57413.xxx	2200/1400W 230V	IECEN 60335-1 IECEN 60335-2-6	VDE Tested in appliance
For Model EO5100, EO5200, EO5300 and EO5410					
Alt. Heating element back left (a)	Ceramaspeed	300T8L8343D	2400/1500W 230V~ φ275/210mm HL type	IECEN 60335-1 IECEN 60335-2-6	VDE Tested in the appliance
For Model EO6400, EO6900					
Heating element front left	10.51311.xxx	EGO	230V 50/60Hz 2300/1600/800W	IEC/EN 60335-1 IEC/EN 60335-2-6	VDE Tested in appliance
Alt. Heating element front left (a)	2302734932	Eika	230V 50/60Hz 2300/1600/800W	IEC/EN 60335-1 IEC/EN 60335-2-6	VDE Tested in appliance
For Model E..... / R..... / M..... / C.....					
Thermostat for heating elements	Electrovac	Z98	12°/250V 8°/400V T250	IECEN 60730-1 IECEN 60730-2-1 IECEN 60730-2-9	VDE ¹⁾⁾
Thermostat for heating elements (a)	EGO	60.25171.003	12° 250V 8° 400V T250	IECEN 60730-1 IECEN 60730-2-1 IECEN 60730-2-9	VDE ¹⁾⁾

IEC 60335-2-6					
Thermostat for heating elements (a)	Electrovac	Z82	12°/250V 7°/400V T250	IECEN 60730-1 IECEN 60730-2-1 IECEN 60730-2-9	VDE ¹⁾
Thermostat for heating elements (a)	Electrovac	Z95	12° 250V 8° 400V T250	IECEN 60730-1 IECEN 60730-2-1 IECEN 60730-2-9	VDE ¹⁾
Thermostat for heating elements (a)	EIKA	TH0xxxxx	12° 250V 8° 400V T250	IECEN 60730-1 IECEN 60730-2-1 IECEN 60730-2-9	VDE ¹⁾
Thermostat for heating elements (a)	Electrovac	Z15	12° 250V 8° 400V T250	IECEN 60730-1 IECEN 60730-2-1 IECEN 60730-2-9	ENEC 10, VDE ¹⁾
Thermostat for heating elements (a)	Electrovac	Z16	12° 250V 8° 400V T250	IECEN 60730-1 IECEN 60730-2-1 IECEN 60730-2-9	Tested with component standard Test report CTI-CB 598-1 by CTI-Vienna
For Model R..... / M.....					
Energy regulators, single zone	Siebe Appliance Controls (Invensys)	MSA V03	15A 240V T125	IECEN 60730-1 IECEN 60730-2-11	BEAB ¹⁾ , VDE ¹⁾
Energy regulators (a)	Siebe Appliance Controls (Invensys)	MSA V01	15A 240V T125	IECEN 60730-1 IECEN 60730-2-11	BEAB ¹⁾ , KEMA ¹⁾
Energy regulators (a)	EGO	50.57021.010	13A 230V μ freq. Op. T125 (the component has been separately tested for 240/400V)	IECEN 60730-1 IECEN 60730-2-11	VDE ¹⁾ , N, S, D, FI, IMQ, KEMA, ÖVE
Energy regulators (a)	EGO	50.55021.100	13A 230V μ T125 (the component has been separately tested for 240/400V)	IECEN 60730-1 IECEN 60730-2-11	VDE ¹⁾ , N, S, D, FI, IMQ, KEMA, ÖVE
Energy regulators (a)	EGO	50.75021.000	230V 13A T125	IECEN 60730-1 IECEN 60730-2-11	VDE
Energy regulators (a)	EGO	50.77021.000	230V 13A T125	IECEN 60730-1 IECEN 60730-2-11	VDE
Energy regulators (a)	EGO	50.57071.041	13A 230V μ T125 (the component has been separately tested for 240/400V)	IECEN 60730-1 IECEN 60730-2-11	VDE ¹⁾ , N, S, D, FI, IMQ, KEMA, ÖVE

IEC 60335-2-6					
Energy regulators (a)	EGO	50.55021.104	13A 230V μ T125 (the component has been separately tested for 240/400V)	IECEN 60730-1 IECEN 60730-2-11	VDE ¹⁾ , N, S, D, FI, IMQ, KEMA, ÖVE
For Model MO.... / MV.... / CO.... / CV....					
Commutator	EGO	46.27266.500	16 A 250V – 10A 400V (PD 58 – WITH CARDAN JOINT)	IECEN 61058-1	VDE ¹⁾
Commutator (a)	EGO	41.41723.005	16 A 250V – 10A 400V (PD 58 – WITH CARDAN JOINT)	IECEN 61058-1	VDE ¹⁾
Commutator (a)	EGO	41.44723.006	16 A 250V – 10A 400V (PD 58 – WITH CARDAN JOINT)	IECEN 61058-1	VDE ¹⁾
Commutator (a)	EGO	Serie 41.4.---.- --	250/400V~ 10A T140	IEC/EN 61058-1	VDE
Commutator (a)	Dreefs	TypeE/01-0508	12 A – 250V - 400V T125 (PD 29-CARDAN JOINT)	IECEN 60335-1 IECEN 60335-2-6 + Annex H	Tested in appliance
Power and control PCB					
Power PCB	EGO	75.13020.303	-	IECEN 60730-2-1 IECEN 60335-1 IECEN 60335-2-6	VDE ¹⁾ Tested in appliance
Power PCB (a)	EGO	75.13020.302	-	IECEN 60730-2-1 IECEN 60335-1 IECEN 60335-2-6	VDE ¹⁾ Tested in appliance
Power PCB (a)	EGO	75.13061.201	4 relays	IECEN 60730-2-1 IECEN 60335-1 IECEN 60335-2-6	VDE ¹⁾ Tested in appliance
Power PCB (a)	EGO	75.13061.202	5 relays	IECEN 60730-2-1 IECEN 60335-1 IECEN 60335-2-6	VDE ¹⁾ Tested in appliance
Power PCB (a)	DDS	DDS218	-	IECEN 60335-1 IECEN 60335-2-6	Tested in appliance
Power PCB (a)	DIEHL	TC3-Q-9T-4R-U230	-	IECEN 60730-2-1 IECEN 60335-1 IECEN 60335-2-6	VDE ¹⁾ Tested in appliance
Power PCB (a)	DDS	DDS151REL	-	IECEN 60335-1 IECEN 60335-2-6	Tested in appliance
Power PCB (a)	DDS	DDS151B	-	IECEN 60730-2-1 IECEN 60335-1 IECEN 60335-2-6	VDE ¹⁾ Tested in appliance
Power PCB (a)	PGA	9901R2,1	-	IECEN 60335-1 IECEN 60335-2-6	Tested in appliance
Power PCB (a)	PGA	9901	-	IECEN 60335-1 IECEN 60335-2-6	Tested in appliance
Power PCB (a)	DIEHL	704455	-	IECEN 60730-2-1 IECEN 60335-1 IECEN 60335-2-6	VDE ¹⁾ Tested in appliance

IEC 60335-2-6					
Power PCB (a)	DIEHL	TC4 SE 13704-014	-	IECEN 60335-1 IECEN 60335-2-6	Tested in appliance
Power PCB (a)	DIEHL	TC4 SE 13704-080	-	IECEN 60335-1 IECEN 60335-2-6	Tested in appliance
Power PCB (a)	DIEHL	701449	-	IECEN 60335-1 IECEN 60335-2-6	Tested in appliance
Power PCB (a)	EIKA	87140036010 011	-	IECEN 60335-1 IECEN 60335-2-6	Tested in appliance
Power PCB (a)	EIKA	86140036010 011	-	IECEN 60335-1 IECEN 60335-2-6	Tested in appliance
Power PCB (a)	EIKA	8A 1..0 360.....	230V 50/60Hz T105	IECEN 60335-1 IECEN 60335-2-6	VDE Tested in appliance
Power PCB (a)	EIKA	8B.1..0 360.....	230V 50/60Hz T105	IECEN 60335-1 IECEN 60335-2-6	VDE Tested in appliance
Control PCB	PGA	9922	-	IECEN 60335-1 IECEN 60335-2-6	Tested in appliance
Control PCB (a)	PGA	9920	-	IECEN 60335-1 IECEN 60335-2-6	Tested in appliance
Control PCB (a)	EGO	75.13022.102	-	IECEN 60335-1 IECEN 60335-2-6	Tested in appliance
Control PCB (a)	Eika	BJ3xxA36211 1xx / BK3xxA36211 1xx	208-240VAC 50/60Hz T105	IECEN 60335-1 IECEN 60335-2-6	Tested in appliance VDE
Control PCB (a)	Eika	BH3xx5360 111xx	220-240V 50/60Hz	IEC/EN 60335-1 IEC/EN 60335-2-6	Tested in appliance
Alternative electronic control board	Diehl AKO Stiftung & Co. KG	TC4 SE4 H	230V~ 50-60Hz 16° T105 PT1175	IECEN 60335-2-6 IECEN 60730-1	3) VDE
Alt. control unit	Diehl AKO Stiftung & Co.	TC5-B-SV-4Z- *R-****	230V 50/60Hz T 105 contact: 250V 10A relays 100 000	IECEN 60730-1 IECEN 60730-2-1 IECEN 60335-1 IECEN 60335-2-6	VDE
Alt. control unit	Diehl AKO Stiftung & Co.	TC5-B-SH-4Z- *R-****	230V 50/60Hz T 105 contact: 250V 10A relays 100 000	IECEN 60730-1 IECEN 60730-2-1 IECEN 60335-1 IECEN 60335-2-6	VDE
Alt. control unit	Diehl AKO Stiftung & Co.	TC5-S-SH-3Z- 4R-****	230V 50/60Hz T 105 contact: 250V 10A relays 100 000	IECEN 60730-1 IECEN 60730-2-1 IECEN 60335-1 IECEN 60335-2-6	VDE
Alt. control unit	Diehl AKO Stiftung & Co.	TC5-S-SL-4Z- *R-T****	230V 50/60Hz T 105 contact: 250V 10A relays 100 000	IECEN 60730-1 IECEN 60730-2-1 IECEN 60335-1 IECEN 60335-2-6	VDE
Alt. control unit	Diehl AKO Stiftung & Co.	TC5-P-SL-4Z- *R-T****	230V 50/60Hz T 105 contact: 250V 10A relays 100 000	IECEN 60730-1 IECEN 60730-2-1 IECEN 60335-1 IECEN 60335-2-6	VDE
Control PCB (a)	EGO	75.13022.103	-	IECEN 60335-1 IECEN 60335-2-6	Tested in appliance

IEC 60335-2-6					
Power PCB (for horizontal mount, 4-zone without double zone)	Eika S. Coop	BN340D36211 107	208-240V~	IEC/EN 60730-1 IEC/EN 60730-2- 11 IEC/EN 60335-1 IEC/EN 60335-2- 6	VDE No: 846000- 4520-0006/ 157788 Tested in appliance
Power PCB (for vertical mount, 4-zone without double zone)	Eika S. Coop	BN340D36211 10B	208-240V~	IEC/EN 60730-1 IEC/EN 60730-2- 11 IEC/EN 60335-1 IEC/EN 60335-2- 6	VDE No: 846000- 4520-0006/ 157788 Tested in appliance
Relays					
Relay	Schrack	LNH30012	16A 250V CLA T70	IECEN 60255-1 IECEN 60255-2- 23 IECEN 60335-1 IECEN 60335-2-6	VDE ¹⁾ Tested in appliance
Relay (a)	Carlo Gavazzi	M25 A 001 12 16	16A/250V (considered as class 105 A)	IECEN 60255-1 IECEN 60255-2- 23 IECEN 60335-1 IECEN 60335-2-6	VDE ¹⁾ Tested in appliance
Relay (a)	Omron	G2RL-1-E	16A/250V/AC1 (considered as class A)	IECEN 60255-1 IECEN 60255-2- 23 IECEN 60335-1 IECEN 60335-2-6	VDE ¹⁾ Tested in appliance
Relay (a)	Matsushita	JS1-12V	10A 230V CL.A T85	IECEN 60255-1 IECEN 60255-2- 23 IECEN 60335-1 IECEN 60335-2-6	VDE ¹⁾ Tested in appliance
Relay (a)	Matsushita	JS1a-12V	10A 230V CL.A T85	IECEN 60255-1 IECEN 60255-2- 23 IECEN 60335-1 IECEN 60335-2-6	VDE ¹⁾ Tested in appliance
Relay (a)	Schrack	RT314012	16A 250V CLA T70	IECEN 60255-1 IECEN 60255-2- 23 IECEN 60335-1 IECEN 60335-2-6	VDE ¹⁾ Tested in appliance
Relay (a)	NAIS	JS1a-B-6V- H150	10A 250V 6Vdc (considered as class A)	IECEN 60255-1 IECEN 60255-2- 23 IECEN 60335-1 IECEN 60335-2-6	VDE ¹⁾ Tested in appliance
Relay (a)	Schrack	LNH33006	10A 250V 6Vdc (considered as class A)	IECEN 60255-1 IECEN 60255-2- 23 IECEN 60335-1 IECEN 60335-2-6	VDE ¹⁾ Tested in appliance

IEC 60335-2-6					
Relay (a)	Schrack	RFH34006	16A 250V 6Vdc (considered as class A)	IECEN 60255-1 IECEN 60255-2-23 IECEN 60335-1 IECEN 60335-2-6	VDE ¹⁾ Tested in the appliance
Relay (a)	Finder	45.71.7.006.0310	16A 250V (considered as class 105 A)	IECEN 60255-1 IECEN 60255-2-23 IECEN 60335-1 IECEN 60335-2-6	IMQ, VDE Tested in the appliance
Relay (a)	Schrack	RTH34012	18A 250V CI.F	IECEN 60255-1 IECEN 60255-2-23 IECEN 60335-1 IECEN 60335-2-6	VDE ¹⁾ Tested in appliance
Relay (a)	Tyco	T 7S V1H6-12-WG	6A 250V CI.F	IECEN 60255-1 IECEN 60255-2-23 IECEN 60335-1 IECEN 60335-2-6	VDE ¹⁾ Tested in appliance
Relay (a)	Hongfa	HF152F-T-012-1HT	10A 250V CI.F 12V	IECEN 60255-1 IECEN 60255-2-23 IECEN 60335-1 IECEN 60335-2-6	VDE ¹⁾ Tested in appliance
Relay (a)	Hongfa	HF152F-T-012-1HTQ	16A 250V CI.F 12V	IECEN 60255-1 IECEN 60255-2-23 IECEN 60335-1 IECEN 60335-2-6	VDE ¹⁾ Tested in appliance
Relay (a)	Hongfa	HF3FA	6A 250V CI.F	IECEN 60255-1 IECEN 60255-2-23 IECEN 60335-1 IECEN 60335-2-6	VDE ¹⁾ Tested in appliance
Relay (a)	Hongfa	HF115F-Q	18A 250V CI.F	IECEN 60255-1 IECEN 60255-2-23 IECEN 60335-1 IECEN 60335-2-6	VDE ¹⁾ Tested in appliance
Relay (a)	Hongfa	881WP2-1AC-F-C	17A 250V CI.F	IECEN 60255-1 IECEN 60255-2-23 IECEN 60335-1 IECEN 60335-2-6	VDE ¹⁾ Tested in appliance
Relay (a)	Matsushita	JS1aP.../T	10A 250V CI.F	IECEN 60255-1 IECEN 60255-2-23 IECEN 60335-1 IECEN 60335-2-6	VDE ¹⁾ Tested in appliance

IEC 60335-2-6					
Relay (a)	Song Chuan	812HT-1A-C E F12V	10A 250V Cl.F	IECEN 60255-1 IECEN 60255-2-23 IECEN 60335-1 IECEN 60335-2-6	VDE ⁽¹⁾ Tested in appliance
Relay (a)	Song Chuan	899-1CH-F-C	10A 250V Cl.F	IECEN 60255-1 IECEN 60255-2-23 IECEN 60335-1 IECEN 60335-2-6	VDE ⁽¹⁾ Tested in appliance
Relay (a)	Song Chuan	SG7 100 E12	16A 250V Cl.F	IECEN 60255-1 IECEN 60255-2-23 IECEN 60335-1 IECEN 60335-2-6	VDE ⁽¹⁾ Tested in appliance
Capacitors					
Capacitor	VISHAY	WKO	4,7nF 250V~ Y2 440V~ X1, T85	IEC 60384-14 IECEN 60335-1 IECEN 60335-2-6	FI ⁽¹⁾ , tested in the appliance
Capacitor	Murata	DE2E3KH472 M	3300pF 250V	IEC 60384-14 IECEN 60335-1 IECEN 60335-2-6	N ⁽¹⁾ , S ⁽¹⁾ , S+ ⁽¹⁾ , VDE ⁽¹⁾ , FI ⁽¹⁾ , D ⁽¹⁾ , tested in the appliance
Capacitor (a)	Murata	KH332H	3300pF 250V~ X1/Y2	IEC 60384-14 IECEN 60335-1 IECEN 60335-2-6	N ⁽¹⁾ , S ⁽¹⁾ , S+ ⁽¹⁾ , VDE ⁽¹⁾ , FI ⁽¹⁾ , D ⁽¹⁾ , tested in the appliance
Capacitor	Philips	336 2 MKP	0,1µF 275V~ X2 T100	IEC 60384-14 IECEN 60335-1 IECEN 60335-2-6	N ⁽¹⁾ , FI ⁽¹⁾ , tested in the appliance
Capacitor (a)	Arcotronics	1.40.00 MKT	0,1µF 275V~ X2 T100	IEC 60384-14 IECEN 60335-1 IECEN 60335-2-6	N ⁽¹⁾ , tested in the appliance
Capacitor (a)	VISHAY	33H2 R0637	0.1µF 275Vac T110	IEC 60384-14	CEBEC
Capacitor (a)	Arcotronics	R.46 MKP X2 SH	0.1µF 275Vac T110	IEC 60384-14	ENEC03, IMQ
Capacitor (a)	BC	22221166116 1109 MKP 338 2	100nF 275V T105	IEC 60384-14	D
X capacitor	ARCOTRONIC	Series R46	100nF X2 110°C	IEC 60384-14	ENEC-IMQ
Alt.	Vishay Röderstein	Series F1710	100nF X1 110°C	IEC 60384-14	VDE
Alt.	Vishay BC-Components	Series E12 MKP339	100nF X2 110°C	IEC 60384-14	ENEC-SGS
Alt.	Vishay BC-Components	Series E12 MKP339T	100nF X2 125°C	IEC 60384-14	ENEC-SGS
Y capacitor	Vishay Draloric	Serie WYO	4n7F Y2 125°C	IEC 60384-14	VDE
Alt.	Murata	Serie KX	4n7F Y2 125°C	IEC 60384-14	VDE

IEC 60335-2-6					
EMI suppression filter	DEM	FC710Y2	250V 0.47µF X2 2x10nF Y 0.68MΩ T85	IEC EN 122400	IMQ
Transformers					
Transformer	Avisor	EI 42/14,5	Prim: 230V~ 50/60Hz 5VA Sec: 9V~ Cl.B	IECEN 61558-1 IECEN 61558-2-6	VDE ¹⁾
Transformer (a)	Mencarini	TRP 01	Prim: 230V~ 50/60Hz Sec: 11V~ 7VA Cl.B	IECEN 60335-1 IECEN 60335-2-6	Tested for use in the appliance
Thermal cut out for the transformer	Tamura Kaken	H130	2A 250V~ 136°C	IECEN 60 691	VDE ¹⁾
Transformer (a)	Marschner	FLG30.10/ 60216	Prim: 230V~ (115+115) 50/60Hz 6VA Sec: 2*12V~ Cl.F	IECEN 61558-1 IECEN 61558-2-6 IECEN 60335-1 IECEN 60335-2-6	VDE ¹⁾ , tested in the appliance
Transformer (a)	Marschner	FLG30.10/610 35-1	6VA 115+115V 50/60Hz 2*12V~ Cl.F	IECEN 61558-1 IECEN 61558-2-6	VDE ¹⁾ ,
Transformer (a)	ERA	BV 030-... type UI 30/10,5	Prim: 230V~ (115+115) 50/60Hz Sec: 2*9V~ Cl.B	IECEN 61558-1 IECEN 61558-2-6	VDE ¹⁾ , S, FI, S+
Transformer (a)	STEGER	08-1120	230V 50/60Hz Cl.F	IECEN 61558-1	VDE ¹⁾
Transformer (a)	ZAREL	2604	230V 50/60Hz 3VA 5/10V ta105/ClassF	IECEN 60335-1 IECEN 60335-2-6 + Annex G	Tested in the appliance
Transformer (a)	Kaschke	451 761	230V 12V Class A	IECEN 60335-1 IECEN 60335-2-6 + Annex G	Tested in the appliance
Transformer (a)	Zarel	03179675 00321004	230V 0-5-10V 3VA 50/60Hz Cl F	IECEN 60335-1 IECEN 60335-2-6 + Annex G	Tested in the appliance
Transformer (a)	Kaschke	063.682	Class B 230V 50Hz	IECEN 60335-1 IECEN 60335-2-6 + Annex G	Tested in the appliance
Transformer (a)	Myrra	25544	85-285VAC / 5-12V cl. ≤ 150	IEC/EN60335-1 IEC/EN60335-2-6	Tested in appliance VDE
Transformer (a)	Myrra	25770	85-285VAC / 5-12V cl. ≤ 150	IEC/EN60335-1 IEC/EN60335-2-6	Tested in appliance VDE
Transformer (a)	Zarel	0321018	85-285VAC / 5-12V cl.B	IEC/EN60335-1 IEC/EN60335-2-6	Tested in appliance VDE
Fuse on power PCB (Not to be replaced by the user)	Italweber	410040	T40mA 250V	IECEN 60127-1	VDE ¹⁾

IEC 60335-2-6					
Fuse on power PCB (Not to be replaced by the user)	various	5x20	T60mA 250V	IECEN 60335-1 IECEN 60335-2-6	Tested in the appliance
For variants no. 147 through 152 only					
Heating element (hob element)					
Heating element	EGO	10.53211.xxx	2500/1100W 230V~ Ø250mm	IECEN 60335-1 IECEN 60335-2-6	VDE Tested in appliance
Heating element	EIKA	2502333912	2500W / 1100W 230V~ Ø250mm	IECEN 60335-1 IECEN 60335-2-6	VDE Tested in appliance
Heating element	EGO	10.52213.xxx	2400/1500W 230V~ Ø290mm	IECEN 60335-1 IECEN 60335-2-6	VDE Tested in appliance
Power and control PCB					
PCB Control unit	Eika	BG3xx336011 1xx	208-240VAC 16-10A 50/60Hz T105	IECEN 60335-1 IECEN 60335-2-6	Tested in appliance VDE
PCB Control unit	Eika	BG3xx336011 1xx	208-240VAC 16-10A 50/60Hz T105	IECEN 60335-1 IECEN 60335-2-6	Tested in appliance VDE
Relays					
Relay	Tyco	LNH33012-01	10A 250V~ Coil: 12Vd.c. Cl.155/F	IECEN 60255-1 IECEN 60255-2-23 IECEN 60335-1 IECEN 60335-2-6	VDE Tested in appliance
<p>1) An asterisk indicates a mark that assures the agreed level of surveillance (a) alternative component</p> <p>2) Energy regulators have been tested in accordance with the conditions occurring in the appliance.</p> <p>3) The control board can have different Code numbers: 714069, 714049, 714012, 714204, 714053, 714052, 714050 and 713364. These cose numbers indicate number of relays, timers, no timers etc.</p>					

28.1	TABLE: Threaded part torque test			P
Threaded part identification	Diameter of thread (mm)	Column number (I, II, or III)	Applied torque (Nm)	
Screw in supply terminal	3,83	II	1,2	
Screw in cord anchorage	3,05	II	0,6	
Screw on enclosure	4	II	1,2	

IEC 60335-2-6

29.1	TABLE: Clearances						P
	Overvoltage category.... :	II				—	
		Type of insulation:					
Rated impulse voltage (V):	Min. cl (mm)	Basic	Functional	Supplementary	Reinforced	Verdict / Remark	
2 500	1,5**	3.2	2.8	--		P	
4 000	3,0**				15	P	
<p>*) The value is increased to 0,8mm for pollution degree 3</p> <p>*) If the construction is affected by wear, distortion, movement of the parts or during assembly, the value is increased by 0,5 mm</p>							

29.2	TABLE: Creepage distances, basic, supplementary and reinforced insulation										P
Working voltage (V)	Creepage distance (mm) Pollution degree										
	1	2			3			Type of insulation			
		Material group			Material group						
		I	II	IIIa/IIIb	I	II	IIIa/IIIb	B ^{*)}	S ^{*)}	R ^{*)}	Verdict
>125 and ≤250	0,6	1,3	1,8	<u>2,5</u>	3,2	3,6	4,0	6	—	—	P
>125 and ≤250	0,6	1,3	1,8	<u>2,5</u>	3,2	3,6	4,0	—	-	—	N/A
>125 and ≤250	1,2	2,6	3,6	<u>5,0</u>	6,4	7,2	8,0	—	—	15	P
>250 and ≤400	1,0	2,0	2,8	<u>4,0</u>	5,0	5,6	6,3	6	—	—	P
>250 and ≤400	1,0	2,0	2,8	<u>4,0</u>	5,0	5,6	6,3	—	-	—	N/A
>250 and ≤400	2,0	4,0	5,6	<u>8,0</u>	10,0	11,2	12,6	—	—	15.0	P
<p>*) , B=Basic, S=Supplementary and R=Reinforced</p>											

29.2	TABLE: Creepage distances, functional insulation								P
Working voltage (V)	Creepage distance (mm) Pollution degree								
	1	2			3				
		Material group			Material group				
		I	II	IIIa/IIIb	I	II	IIIa/IIIb	Verdict / Remark	
>125 and ≤250	0,4	1,0	1,4	<u>2,0</u>	2,5	2,8	3,2	P / 2,8	
>250 and ≤400	0,8	1,6	2,2	<u>3,2</u>	4,0	4,5	5,0	P / 10.0	

IEC 60335-2-6

30																			TABLE: Resistance to heat and fire																		
Object/ part No.	Manufacturer/ trademark	Type/ model	Ball pressure test °C				Glow wire test (GWT) °C					Glow-wire flammability index (GWFI) °C				Glow- wire ignition temp. (GWIT) °C		Needle - flame test (NFT)	Verdict																		
			75	125	cl. 11 +40	cl. 19 +25	550	650		750		850	550	650	750	850	675			775																	
							te		ti																												
Energy regulators	Siebe Appliance	MSA V01			163					0	0	x							P																		
Energy regulators	Siebe Appliance	MSA V03			163					0	0	x							P																		
Energy regulators	Siebe Appliance	MSA 312			163					0	0	x							P																		
Energy regulators	Siebe Appliance	MSA 369			163					0	0	x							P																		
Switch	EGO				135					0	0	x							P																		
Plastic cover to terminals			75					x											P																		
Supply screw terminal				125						0	0	x							P																		
Cover of screw terminal			75					x											P																		
DDS electronic board DDS218 and DDS151REL																																					
Transformer				125						0	0	x							P																		

IEC 60335-2-6

Object/ part No.	Manufacturer/ trademark	Type/ model	Ball pressure test °C				Glow wire test (GWT) °C				Glow-wire flammability index (GWFI) °C				Glow- wire ignition temp. (GWIT) °C		Needle - flame test (NFT)	Verdict		
			75	125	cl. 11 +40	cl. 19 +25	550	650		750		850	550	650	750	850			675	775
							te		ti											
Relay				125						0	0	x							P	
PCB				125						0	0	x						x	P	
EIKA electronic board 8A 1..0 360..... or 8B.1..0 360..... or BJ(K)3..A36...1.. and DIEHL electronic board TC-4SE-Z-XX-YY-105-U230																				
PCB				125						0	0	x						x	P	
Relay cover				125						0	0	x							P	
Zarel transformer cover				125						0	0	x							P	
X2 capacitor				125						0	0	x							P	
Plastic part of Kaschke transformer				125						0	0	x							P	
Coil support				125						0	0	x							P	
EGO electronic board 75.13061.201 (4 relays) or 75.13061.202 (5 relays)																				
PCB				105						0	0	x						x	P	
Relay cover	SCHRACK	LNA 333012		99			x												P	

IEC 60335-2-6

Object/ part No.	Manufacturer/ trademark	Type/ model	Ball pressure test °C				Glow wire test (GWT) °C				Glow-wire flammability index (GWFI) °C				Glow- wire ignition temp. (GWIT) °C		Needle - flame test (NFT)	Verdict	
			75	125	cl. 11 +40	cl. 19 +25	550	650		750		850	550	650	750	850			675
								te	ti	te	ti								
Relay contact side	SCHRACK	LNA 333012		125						0	0	x							P
Transformer Cover	ERA				109		x												P
Transformer Contact side	ERA			125						0	0	x							P
DIEHL electronic board TC3-Q-9T-4R-U230																			
Relay NAIS				125						0	0	x							P
Relay FINDER				125						0	0	x							P
X2 capacitor				125						0	0	x							P
PCB				125						0	0	x						x	P
Transformer (plastic part)				125						0	0	x							P
Coil frame				125						0	0	x							P
DIEHL electronic board TC4 Standard H																			
PCB				125						0	0	x						x	P

IEC 60335-2-6

Object/ part No.	Manufacturer/ trademark	Type/ model	Ball pressure test °C				Glow wire test (GWT) °C				Glow-wire flammability index (GWFI) °C				Glow- wire ignition temp. (GWIT) °C		Needle - flame test (NFT)	Verdict	
			75	125	cl. 11 +40	cl. 19 +25	550	650		750		850	550	650	750	850			675
								te	ti	te	ti								
Relay	SCHRACK	RFH34 006		125						0	0	x							P
Relay	SCHRACK	LNH33 0006		125						0	0	x							P
Transformer (plastic parts)	Kaschke			125						0	0	x							P
X2 capacitor				125						0	0	x							P
Coil frame				125						0	0	x							P
Fast on cover					114		x												P
EIKA electronic board: BJ3xxA36211101																			
PCB				125						0	0	x						x	P
Relay cover				125						0	0	x							P
transformer bobbin				125						0	0	x							P
X2 capacitor				125						0	0	x							P

IEC 60335-2-6

Object/ part No.	Manufacturer/ trademark	Type/ model	Ball pressure test °C				Glow wire test (GWT) °C				Glow-wire flammability index (GWFI) °C				Glow- wire ignition temp. (GWIT) °C		Needle - flame test (NFT)	Verdict	
			75	125	cl. 11 +40	cl. 19 +25	550	650		750		850	550	650	750	850			675
Eika BN340D3621110x																			
PCB				125						0	0	X						x	P
Relay	Song chuan	812HT		125						0	0	x							P
Supplementary information: 1) Parts of material classified at least HB40 or if relevant HBF 2) Parts of material classified as V-0 or V-1 3) Flame persisting longer than 2 s (= te – ti) need only be reported for unattended appliances 4) Surrounding parts subjected to the needle-flame test of annex E 5) Base material classified as V-0 or if relevant VTM-0 6) The GWIT pre-selection option, the 850 °C GWFI pre-selection option, and the 850 °C GWT are not applicable for attended appliances																			

IEC60335_2_6J - ATTACHMENT			
Clause	Requirement – Test	Result – Remark	Verdict
ATTACHMENT TO TEST REPORT IEC 60335-2-6 EUROPEAN GROUP DIFFERENCES AND NATIONAL DIFFERENCES (Household and similar electrical appliances – Safety – Part 2: Particular requirements for stationary cooking ranges, hobs, ovens and similar appliances)			
Differences according to:	EN 60335-2-6: 2003 + A1:2003 + A2: 2008 + A11: 2010 + A12:2012 + A13:2013 used in conjunction with EN 60335-1:2012 EN 62233:2008		
Attachment Form No.:	EU_GD_IEC60335_2_6J_II		
Attachment Originator:	Electrosuisse		
Master Attachment:	2013-11		
Copyright © 2013 IEC System for Conformity Testing and Certification of Electrical Equipment (IECEE), Geneva, Switzerland. All rights reserved.			

IEC 60335-2-6J - ATTACHMENT EN 62233:2008			
Clause	Requirement + Test	Result – Remark	Verdict
EMF- ELECTROMAGNETICS FIELDS			
	The tested product also complies with the requirements of EN 62233:2008		
	Limit 100%	Measured max. :... < 5%	P

IEC 60335_2_6J - ATTACHMENT			
Clause	Requirement – Test	Result – Remark	Verdict
CENELEC COMMON MODIFICATIONS			
6.1	Delete “class 0” and “class 01”		P
7.1	Single-phase appliances to be connected to the supply mains: 230 V covered		P
	Multi-phase appliances to be connected to the supply mains: 400 V covered		P
	When the provisions of footnote a to Table 102 apply, the appliance shall be marked with: (EN 60335-2-6)		-
	– the substance of “CAUTION: Hot surface”, or		N/A
	– symbol IEC 60417-5041		N/A
	The warning label shall be put on the door of pyrolytic ovens and shall be visible during operation (EN 60335-2-6)		N/A
7.10	Devices used to start/stop operational functions of the appliance distinguished from other manual devices by means of shape, size, surface texture, position, etc.	Models “R”, “C”, “M”, tactile feedback; Models “E”, visual + audible feedback.	P
	An indication that the device has been operated is given by:		-

IEC60335_2_6J - ATTACHMENT			
Clause	Requirement – Test	Result – Remark	Verdict
	<ul style="list-style-type: none"> • a tactile feedback, or 	Models “R”, “C”, “M”	P
	<ul style="list-style-type: none"> • an audible and visual feedback 	Models “E”	P
	Devices used to stop operational functions of the appliance, if any, shall be distinguished from other manual devices by means of shape, or size, or surface texture, or position, etc. A tactile or an audible and visual feedback shall give an indication that the device has been operated. (EN 60335-2-6)		P
7.12	The instructions include the substance of the following:		-
	- this appliance can be used by children aged from 8 years and above and persons with reduced physical, sensory or mental capabilities or lack of experience and knowledge if they have been given supervision or instruction concerning use of the appliance in a safe way and understand the hazards involved		P
	- children shall not play with the appliance		P
	- cleaning and user maintenance shall not be made by children without supervision		P
	Instructions for use shall be provided with the appliance so that the appliance can be used safely (EN 60335-2-6)		P
	It is necessary to take precautions during user maintenance, appropriate details shall be given		P
	The instructions shall include the substance of the following: (EN 60335-2-6) WARNING: The appliance and its accessible parts become hot during use. Care should be taken to avoid touching heating elements. Children less than 8 years of age shall be kept away unless continuously supervised.		P
	This appliance can be used by children aged from 8 years and above and persons with reduced physical, sensory or mental capabilities or lack of experience and knowledge if they have been given supervision or instruction concerning use of the appliance in a safe way and understand the hazards involved. Children shall not play with the appliance. Cleaning and user maintenance shall not be made by children without supervision (EN 60335-2-6)		P
	The instructions for hobs and ranges shall include the substance of the following: (EN 60335-2-6) WARNING: Unattended cooking on a hob with fat or oil can be dangerous and may result in fire. NEVER try to extinguish a fire with water, but switch off the appliance and then cover flame e.g. with a lid or a fire blanket. WARNING: Danger of fire: do not store items on the cooking surfaces		P

IEC60335_2_6J - ATTACHMENT			
Clause	Requirement – Test	Result – Remark	Verdict
	If the hob surface is of glass-ceramic or similar material and protects live parts, the instructions shall include the substance of the following: WARNING: If the surface is cracked, switch off the appliance to avoid the possibility of electric shock. (EN 60335-2-6)		P
	The instructions for cooking ranges and ovens shall include the substance of the following: During use the appliance becomes hot. Care should be taken to avoid touching heating elements inside the oven.(EN 60335-2-6)		N/A
	The instructions for ovens shall include the substance of the following: (EN 60335-2-6) WARNING: Accessible parts may become hot during use. Young children should be kept away.		N/A
	The instructions for ovens having doors with glass panels shall include the substance of the following: (EN 60335-2-6) Do not use harsh abrasive cleaners or sharp metal scrapers to clean the oven door glass since they can scratch the surface, which may result in shattering of the glass.		N/A
	If during the test of Clause 11, the temperature rise at the centre of the internal bottom surface of a storage drawer exceeds that specified for handles held for short periods in normal use, the instructions shall state that these surfaces can get hot. (EN 60335-2-6)		N/A
	The instructions for pyrolytic self-cleaning ovens shall state that excess spillage must be removed before cleaning and shall specify which utensils can be left in the oven during cleaning (EN 60335-2-6)		N/A
	If, for cleaning, the manufacturer instructs the user to set the controls to a position higher than for normal cooking purposes, the instructions shall state that under such conditions the surfaces may get hotter than usual and children should be kept away. (EN 60335-2-6)		N/A
	The instructions for ovens incorporating a fan with a guard that can be removed for cleaning shall state that the oven must be switched off before removing the guard and that, after cleaning, the guard must be replaced in accordance with the instructions (EN 60335-2-6)		N/A
	The instructions for ovens provided with a facility to use a temperature-sensing probe shall include the substance of the following: (EN 60335-2-6) Only use the temperature probe recommended for this oven.		N/A

IEC60335_2_6J - ATTACHMENT			
Clause	Requirement – Test	Result – Remark	Verdict
	The instructions for ovens that have shelves shall include details indicating the correct installation of the shelves. (EN 60335-2-6)		N/A
	The instructions for cooking ranges, hobs and ovens shall state that a steam cleaner is not to be used. (EN 60335-2-6)		P
	The instructions for induction hobs shall include the substance of the following: (EN 60335-2-6) Metallic objects such as knives, forks, spoons and lids should not be placed on the hob surface since they can get hot.		N/A
	The instructions for hobs incorporating a lid shall state that any spillage should be removed from the lid before opening. They shall also state that the hob surface should be allowed to cool before closing the lid. (EN 60335-2-6)		N/A
	The instructions for hobs incorporating halogen lamps shall warn the user not to stare at the hob elements.		N/A
	The instructions for hobs incorporating a pan detector shall include the substance of the following: (EN 60335-2-6) After use, switch off the hob element by its control and do not rely on the pan detector.		N/A
	If the appliance incorporates a lamp for illumination, and does not incorporate a switch providing full disconnection under overvoltage category III conditions, the instructions shall include the substance of the following: WARNING: Ensure that the appliance is switched off before replacing the lamp to avoid the possibility of electric shock. (EN 60335-2-6)		N/A
	The instructions for hobs shall state that the appliance is not intended to be operated by means of an external timer or separate remote-control system. (EN 60335-2-6)		P
	The instructions for hobs shall include the substance of the following: WARNING: Use only hob guards designed by the manufacturer of the cooking appliance or indicated by the manufacturer of the appliance in the instructions for use as suitable or hob guards incorporated in the appliance. The use of inappropriate guards can cause accidents. (EN 60335-2-6)		P
	The instructions for hobs incorporating an induction wok element shall contain a list of vessels that can be used, unless the manufacturer provides a work with the appliance. (EN 60335-2-6)		N/A

IEC60335_2_6J - ATTACHMENT			
Clause	Requirement – Test	Result – Remark	Verdict
7.12.Z101	Add the following new subclause before 7.12.1: The specific instructions related to the safe operation of this appliance (as given in 7.12 of this standard) shall be collated together in the front section of the user instructions. The height of the characters, measured on the capital letters, shall be at least 4 mm. (EN 60335-2-6)	Corrigendum to EN 60335-2-6:2003/A11:2010, June 2012, had changed “4 mm” to “at least 3 mm”.	P
	These instructions shall also be available in an alternative format, e.g. on a website.		P
7.12.Z1	The specific instructions related to the safe operation of this appliance is collated together in the front section of the user instructions		P
	The height of the characters, measured on the capital letters, is at least 3 mm		P
	These instructions are also available in an alternative format, e.g. on a website		P
7.14	The height of the triangle used with symbol IEC 60417-5041 shall be at least 12 mm. (EN 60335-2-6)		N/A
8.1.1	Also test probe 18 of EN 61032 is applied		P
	The appliance being in every possible position during the test		P
	The force on the probe in the straight position is increased to 10 N when probe 18 is used		P
	When using test probe 18 the appliance is fully assembled as in normal use without any parts removed, and		P
	parts intended to be removed for user maintenance are also not removed		P
	Use of test probe B and probe 18 of IEC 61032: no contact with live parts (EN 60335-2-6)		P
8.2	Compliance is checked by applying the test probes of EN 61032		P
	For built-in appliances and fixed appliances, the test probe B and probe 18 of EN 61032 are applied only after installation		P
11.8	Footnotes to “External enclosure of motor-operated appliances” to be taken into account		N/A
11.101	Temperature rise of surfaces not exceed the values specified in Table 102 (EN 60335-2-6)	See appended table	N/A
15.1.2	Appliances with an automatic cord reel tested with the cord in the most unfavourable position so that the reeling of the wet cord may affect electrical insulation during operation, the cord not being dried before reeling		N/A
19.102	Thermal control by NTC: replace by resistor with middle of the range value (EN 60335-2-6)		N/A

IEC60335_2_6J - ATTACHMENT			
Clause	Requirement – Test	Result – Remark	Verdict
20.2	When using the test probe similar to test probe B with a circular stop face, the accessories and detachable covers are removed		N/A
	Test probe 18 applied with a force of 2,5N on the appliance fully assembled		N/A
	Appliances are fully assembled as in normal operation without any parts removed. (EN 60335-2-6)		N/A
20.101	Stability test with the oven in its intended position following manufacturer's instructions (EN 60335-2-6)		N/A
20.Z101	Horizontally hinged oven doors of floor standing cooking ranges, when fully opened, shall not cause a hazard. (EN 60335-2-6)		N/A
21.101	Inclination difference between empty inside and loaded in rest position shall not exceed 6° (EN 60335-2-6)		N/A
21.102	In the third paragraph of the test specification, replace "The vessel" by "For hob elements, other than induction wok elements, the vessel". (EN 60335-2-6)		P
22.12	Handles, knobs etc. fixed in a reliable manner so that they will not work loose in normal use if loosening could result in a hazard (including ingestion or a choking hazard for vulnerable people". (EN 60335-2-6)		P
22.122	Ovens with shelves that can be withdrawn shall be fitted with rest or stop positions (EN 60335-2-6)		N/A
	This requirement does not apply to shelves that are designed to contain liquids, such as roasting trays and the like. (EN 60335-2-6)		N/A
24.1	Components comply with the safety requirements specified in the relevant standards as far as they reasonably apply		P
	The requirements of Clause 29 of this standard apply between live parts of components and accessible parts of the appliance.		P
	The requirements of 30.2 of this standard apply to parts of non-metallic material in components including parts of non-metallic material supporting current-carrying connections inside components		P
	Components that have not been previously tested or do not comply with the standard for the relevant component are tested according to the requirements of 30.2		P

IEC60335_2_6J - ATTACHMENT			
Clause	Requirement – Test	Result – Remark	Verdict
	Components that have been previously tested and shown to comply with the resistance to fire requirements in the standard for the relevant component need not be retested provided that:		-
	- the severity specified in the component standard is not less than the severity specified in 30.2, and		P
	- the test report for the component states whether it complied with the standard for the relevant component with or without flame, flames not exceeding 2 s during the test are ignored		P
	Unless components have been previously tested and found to comply with the relevant standard for the number of cycles specified, they are tested in accordance with 24.1.1 to 24.1.9		N/A
	For components mentioned in 24.1.1 to 24.1.9, no additional tests specified in the relevant standard for the component are necessary other than those specified in 24.1.1 to 24.1.9		N/A
	Components that have not been separately tested and found to comply with the relevant standard, and		P
	components that are not marked or not used in accordance with their marking,		P
	are tested in accordance with the conditions occurring in the appliance, the number of samples being that required by the relevant standard		P
	Lamp holders and starter holders that have not been previously tested and found to comply with the relevant standard are tested as a part of the appliance and additionally comply with the gauging and interchangeability requirements of the relevant standard under the conditions occurring in the appliance		N/A
	Where the relevant standard specifies these gauging and interchangeability requirements at elevated temperatures, the temperatures measured during the tests of Clause 11 are used		N/A
	Plugs and socket-outlets and other connecting devices of interconnection cords are not interchangeable with plugs and socket-outlets listed in IEC/TR 60083 or IEC 60906-1, or		N/A
	with connectors and appliance inlets complying with the standard sheets of IEC 60320-1,		N/A
	if direct supply to these parts from the supply mains gives rise to a hazard		N/A
24.1.7	If the remote operation of the appliance is via a telecommunication network, the relevant standard for the telecommunication interface circuitry in the appliance is EN 41003		N/A

IEC60335_2_6J - ATTACHMENT			
Clause	Requirement – Test	Result – Remark	Verdict
	Compliance with Clause 8 of this standard is not impaired by connecting the appliance to a device covered by EN 41003		N/A
24.Z1	For motor running capacitors (IEC 60252-1 type P2) with a metallic enclosure having an overpressure fuse the flame testing of internal plastic parts supporting current carrying connections as required in 30.2.2 and 30.2.3.1 is not necessary		N/A
25.6	Supply cords of single-phase portable appliances having a rated current not exceeding 16 A, fitted with a plug complying with the following standard sheets of IEC/TR 60083:		-
	- for Class I appliances: standard sheet C2b, C3b or C4		N/A
	- for Class II appliances: standard sheet C5 or C6		N/A
25.7	Rubber sheathed cords (60245 IEC 53) are not suitable for appliances intended to be used outdoors or when they are liable to be exposed to significant amount of ultraviolet radiation	Not for outdoor used	N/A
	Halogen-free thermoplastic compound sheathed supply cords have properties at least those of:		-
	<ul style="list-style-type: none"> halogen-free thermoplastic compound sheathed cords (H03Z1Z1H2-F or H03Z1Z1-F), for appliances having a mass not exceeding 3 kg 		N/A
	<ul style="list-style-type: none"> halogen-free thermoplastic compound sheathed cords (H05Z1Z1H2-F or H05Z1Z1-F), for other appliances 		N/A
	Cross-linked halogen-free compound sheathed supply cords have properties at least those of cross-linked halogen-free compound sheathed cords (H07ZZ-F)		N/A
26.11	Conductors connected by soldering are not considered to be positioned or fixed so that reliance is not placed upon the soldering alone to maintain them in position unless they are held in place near the terminals independently of the solder		N/A
29.2	The macroenvironment in a domestic kitchen is pollution degree 2 (EN 60335-2-6)		P
	The microenvironment inside the appliance may be pollution degree 2 or 3 (EN 60335-2-6)	pollution degree 2	P
29.3.Z1	Appliance constructed so that if there is a possibility of damaging the insulation during installation, the insulation withstands the scratch and penetration test of 21.2		N/A
32	Compliance regarding electromagnetic fields is checked according to EN 50366 or EN 62233		P

IEC60335_2_6J - ATTACHMENT			
Clause	Requirement – Test	Result – Remark	Verdict
Annex I, 19.1.101	The appliance is supplied at rated voltage and operated under normal operation with each of the fault conditions specified		N/A
	The duration of the test is as specified in 19.7		N/A
ZA	ANNEX ZA (NORMATIVE) SPECIAL NATIONAL CONDITIONS		
	Norway		
19.5	The test is also applicable to appliances intended to be permanently connected to fixed wiring		N/A
	Norway		
22.2	The second paragraph of this subclause, dealing with single-phase, permanently connected class I appliances having heating elements, is not applicable due to the supply system		N/A
	All CENELEC countries		
25.6 and 25.25	Information concerning National plug and socket-outlets is available from the CENELEC website. Normative national requirements concerning plug and socket-outlets are shown in the relevant National standard	Supply cord for fixed connection	N/A
	Ireland and United Kingdom		
25.8	In the table, the lines for 10 A and 16 A are replaced by:		-
	> 10 and ≤ 13 1,25		P
	> 13 and ≤ 16 1,5		P
ZB	ANNEX ZB (INFORMATIVE) A-DEVIATIONS		
	Ireland		
25.6	These regulations apply to all plugs for domestic use at a voltage of not less than 200 V and in general allow only plugs complying with I.S. 401:1997, or equivalent, to be fitted to domestic appliances	To be checked before marketing in this country	-

IEC60335_2_6J - ATTACHMENT			
Clause	Requirement – Test	Result – Remark	Verdict
United Kingdom			
25.6	These regulations apply to all plugs for domestic use at a voltage of not less than 200 V and in general allow only plugs to BS 1363 to be fitted to domestic appliances. It also allows plugs to BS 4573 and EN 50075 to be fitted to shavers and toothbrushes	To be checked before marketing in this country	-
ZC			
ANNEX ZC (NORMATIVE)		NORMATIVE REFERENCES TO INTERNATIONAL PUBLICATIONS WITH THEIR CORRESPONDING EUROPEAN PUBLICATIONS	
	A list of referenced documents in this standard		P
ZD			
ANNEX ZD (INFORMATIVE)		IEC and CENELEC CODE DESIGNATIONS FOR FLEXIBLE CORDS	
	A table with IEC and CENELEC code designations for flexible cords		P
ZE			
ANNEX ZE (INFORMATIVE)		SPECIFIC ADDITIONAL REQUIREMENTS FOR APPLIANCES AND MACHINES INTENDED FOR COMMERCIAL USE	
7.1	Business name and full address of the manufacturer and, where applicable, his authorized representative.....:		N/A
	Model or type reference		N/A
	Serial number, if any		N/A
	Production year		N/A
	Designation of the appliance		N/A
7.12	Instructions provided with the appliance so that the appliance can be used safely		N/A
	The instructions contain at least the following information:		-
	- the business name and full address of the manufacturer and, where applicable, his authorized representative		N/A
	- model or type reference of the appliance as marked on the appliance itself, except for the serial number		N/A
	- the designation of the appliance together with its explanation in case it is given by a combination of letters and/or numbers		N/A
	- the general description of the appliance, when needed due to the complexity of the appliance		N/A

IEC60335_2_6J - ATTACHMENT			
Clause	Requirement – Test	Result – Remark	Verdict
	- specific precautions if required during installation, operation, adjusting, user maintenance, cleaning, repairing or moving		N/A
	- when needed drawings, diagrams, descriptions and explanations necessary for the safe use and user maintenance of the appliance		N/A
	- the possible reasonably foreseeable misuse and, whenever relevant, a warning against the effects it may have on the safe use of the appliance		N/A
	The words “Original instructions” appear on the language version(s) verified by the manufacturer or by the authorized representative		N/A
	When a translation of the original instructions has been provided by a person introducing the appliance on the market; the meaning of the sentence “Translation of the original instructions” appear in the relevant instructions delivered with the appliance		N/A
	The instructions for maintenance/service to be done by specialized personnel, mandated by the manufacturer or the authorized representative may be supplied in only one Community language which the specialized personnel understand		N/A
	The instructions indicate the type and frequency of inspections and maintenance required for safe operation including the preventive maintenance measures		N/A
7.12.ZE1	If needed for specific appliances, the following information to be given:		-
	<ul style="list-style-type: none"> on use, transportation, assembly, dismantling when out of service, testing or foreseeable breakdowns, if these operations have consequences on stability of the appliance in order to avoid overturning, falling or uncontrolled movements of the appliance or of its component parts 		N/A
	<ul style="list-style-type: none"> on how to maintain adequate mechanical stability when in use, during transportation, assembly, dismantling, scrapping and any other action involving the appliance 		N/A
	<ul style="list-style-type: none"> on the protective measures to be taken by the user, including, where appropriate, the personal protective equipment to be provided 		N/A
	<ul style="list-style-type: none"> on the operating method to be followed in the event of accident or breakdown; if a blockage is likely to occur the operating method to safely unblock the appliance 		N/A
	<ul style="list-style-type: none"> on the specifications on the spare parts to be used, when these affect the health and safety of the operator 		N/A

IEC60335_2_6J - ATTACHMENT			
Clause	Requirement – Test	Result – Remark	Verdict
	<ul style="list-style-type: none"> on airborne noise emissions, determined and declared in accordance with the relevant Part 2, which includes: 		-
	- the A-weighted emission sound pressure level at workstations, where this exceeds 70 dB(A)		N/A
	- where this level does not exceed 70 dB(A), this fact is indicated		N/A
	- the peak C-weighted instantaneous sound pressure value at workstations, where this exceeds 63 Pa (130 dB in relation to 20 µPa).....		N/A
	- the A-weighted sound power level emitted by the machinery, where the A-weighted emission sound pressure level at workstations exceeds 80 dB(A).....		N/A
7.12.ZE2	The instructions includes a warning to disconnect the appliance from its power source during service and when replacing parts		N/A
	If the removal of the plug is foreseen, it is clearly indicated that the removal of the plug has to be such that an operator can check from any of the points to which he has access that the plug remains removed		N/A
	If this is not possible, due to the construction of the appliance or its installation, a disconnection with a locking system in the isolated position is provided		N/A
19.11.4.8	The appliance continues to operate, without causing any hazard to the user, from the same point in its operating cycle at which the voltage fluctuation occurred, or		N/A
	a manual operation is required to restart it		N/A
20.1	Appliances and their components and fittings have adequate mechanical stability during transportation, assembly, dismantling and any other action involving the appliance		N/A
20.2	Dangerous moving transmission parts safeguarded either by design or guards		N/A
	When guards are used, they are fixed guards, interlocking movable guards or protective devices		N/A
	Moving parts directly involved in the function of the appliance which cannot be made completely inaccessible fitted with:		-
	- fixed guards or interlocking movable guards preventing access to those sections of the parts that are not used in the work, and		N/A
	- adjustable guards restricting access to those sections of the moving parts where access is necessary		N/A

IEC60335_2_6J - ATTACHMENT			
Clause	Requirement – Test	Result – Remark	Verdict
	Interlocking movable guards used where frequent access is required		N/A
21.1	Appliances and their components and fittings have adequate mechanical strength and is constructed to withstand such rough handling that may be expected in normal use, during transportation, assembly, dismantling, scrapping and any other action involving the appliance		N/A
22.ZE.1	For appliances provided with a seat, the seat gives adequate stability		N/A
	The distance between the seat and the control devices capable of being adapted to the operator		N/A
22.ZE.2	For appliances provided with separate devices for the start and the stop functions, the stop function is unambiguously identifiable and does always override the start function		N/A
	For appliances provided with one device performing the start and the stop function, the stop function is unambiguously identifiable and does always override the start function		N/A
22.ZE.3	Appliances designed in such a way that incorrect mounting is avoided, if this can lead to an unsafe situation		N/A
	If this is not possible, information on the correct mounting is given directly on the part and/or the enclosure		N/A
22.ZE.4	Where the weight, size or shape prevents appliances from being moved manually, they are fitted with attachments for lifting gear, or		N/A
	so designed that they can be fitted with such attachments, or		N/A
	be shaped in such a way that standard lifting gear can easily be used		N/A
	Appliances to be moved manually are constructed or equipped so that they can be moved easily and safely		N/A
22.ZE.5	The fixing systems of fixed guards which prevent access to dangerous moving transmission parts only removable with the use of tools		N/A
	If such guards have to be removed by the user for routine cleaning or maintenance their fixing systems remain attached to the fixed guards or to the machine after removal		N/A
	Where possible, guards are incapable of remaining in place without their fixings		N/A
	This does not apply if, after removal of the screws, or if the component is incorrectly repositioned, the appliance becomes inoperative		N/A

IEC60335_2_6J - ATTACHMENT			
Clause	Requirement – Test	Result – Remark	Verdict
	Movable guards are interlocked		N/A
	The interlocking devices prevent the start of hazardous appliance functions until the guards are fixed in their position, and give a stop command whenever they are no longer closed		N/A
	Where it is possible for an operator to reach the danger zone before the risk due to hazardous appliance functions has ceased, movable guards associated with a guard locking device in addition to an interlocking device that:		-
	- prevents the start of hazardous appliance functions until the guard is closed and locked, and		N/A
	- keeps the guard closed and locked until the risk of injury from the hazardous appliance functions has ceased		N/A
	Interlocking movable guards remain attached to the appliance when open, and		N/A
	they are designed and constructed in such a way that they can be adjusted only by means of an intentional action		N/A
22.ZE.6	Interlocking movable guards designed in such a way that the absence or failure of one of their components prevents starting or stops the hazardous appliance functions		N/A
	The guard is opened to the extent needed to cause the interlocking to operate and is then closed, the number of operations being defined in the specific Part 2.....:		N/A
	After this test any defect that may be expected in normal use is applied to the interlock system, including interruption of the supply, only one defect being simulated at a time		N/A
	After these tests the interlock system is fit for further use		N/A
22.ZE.7	Adjustable guards restricting access to areas of the moving parts strictly necessary for the work are:		-
	- adjustable manually or automatically, depending on the type of work involved, and		N/A
	- readily adjustable without the use of tools		N/A
22.ZE.8	In case of interruption, re-establishment after an interruption or fluctuation in whatever manner of the power supply, the appliance does not restart		N/A
	However, automatic restarting of the operation is allowed if the appliance may continue to operate, without causing any hazard to the user, from the same point in its operating cycle at which the voltage interruption or fluctuation occurred		N/A

IEC60335_2_6J - ATTACHMENT			
Clause	Requirement – Test	Result – Remark	Verdict
22.ZE.9	Appliances fitted with means to isolate them from all energy sources		N/A
	Such isolators are clearly identified, and		N/A
	they are capable of being locked if reconnection endanger persons		N/A
	After the energy source is disconnected, it is possible to dissipate any energy remaining or stored in the circuits of the appliance without risk to persons		N/A
ZF	ANNEX ZF (INFORMATIVE) CRITERIA APPLIED FOR THE ALLOCATION OF PRODUCTS COVERED BY STANDARDS IN THE EN 60335 SERIES UNDER LVD OR MD		
	List of standards under CENELEC/TC61 with the allocation under the LVD (Low Voltage Directive) or the MD (Machinery Directive)	LVD	P
ZG	ANNEX ZG (NORMATIVE) UV APPLIANCES		
	The following modifications to this standard apply to appliances having UV emitters		N/A
	This annex is not applicable to appliances covered by the scopes of IEC 60335-2-27, IEC 60335-2-59 or IEC 60335-2-109		N/A
7.12.ZG	The instructions for appliances incorporating UVC emitters include the substance of the following: WARNING — This appliance contains a UV emitter. Do not stare at the light source		N/A
32	For appliances incorporating UV emitters the manufacturer delivers a declaration providing evidence that the plastic material exposed to the radiation is UV resistant		N/A
ZZ	ANNEX ZZ (INFORMATIVE) COVERAGE OF ESSENTIAL REQUIREMENTS OF EC DIRECTIVES		
	Description of the relation between this European standard and the LVD (Low Voltage Directive, 2006/95/EC) and the MD (Machinery Directive, 2006/42/EC)		P

IEC60335_2_6J - ATTACHMENT

Clause	Requirement – Test	Result – Remark	Verdict
--------	--------------------	-----------------	---------

11.101	TABLE: Temperature rise limits for surfaces					
	Ambient (°C):					
	Test voltage (V):					
Surface	Surfaces of appliances situated not more than 850 mm above the floor after installation				Surfaces situated more than 850 mm above the floor after installation	
	Front surfaces of oven door		Other parts			
	dT (K)	Max. dT (K)	dT (K)	Max. dT (K)	dT (K)	Max. dT (K)
Bare metal		40		45		45
Coated metal		45		55		55
Glass and ceramic		55		60		60
Plastic and plastic coating > 0,3 mm		60		65		65

Comparison of normal dimension and slim dimension - ATTACHMENT

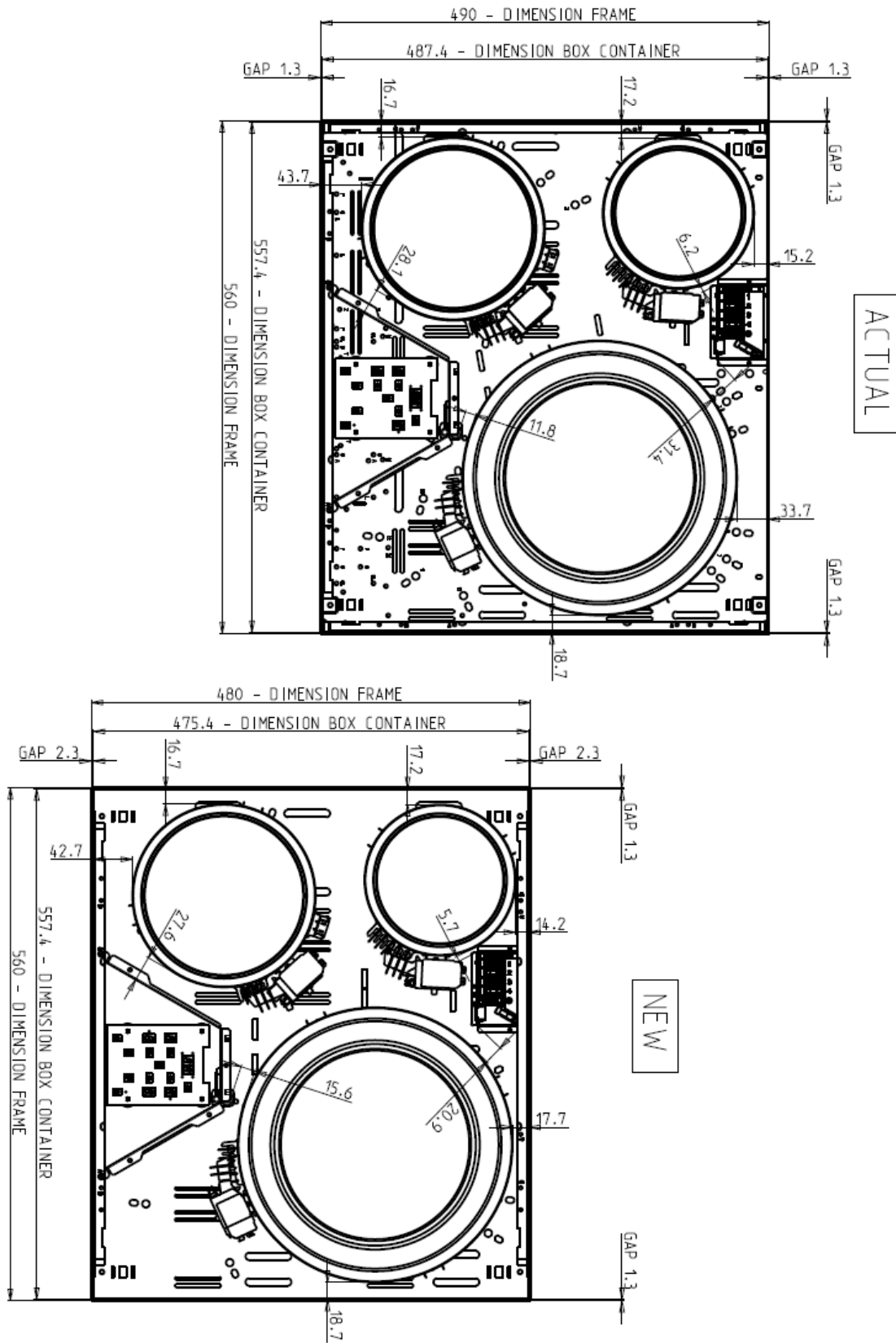

the overall dimensions in above drawings also apply to drawings in following 2 pages.

Comparison of normal dimension and slim dimension - ATTACHMENT

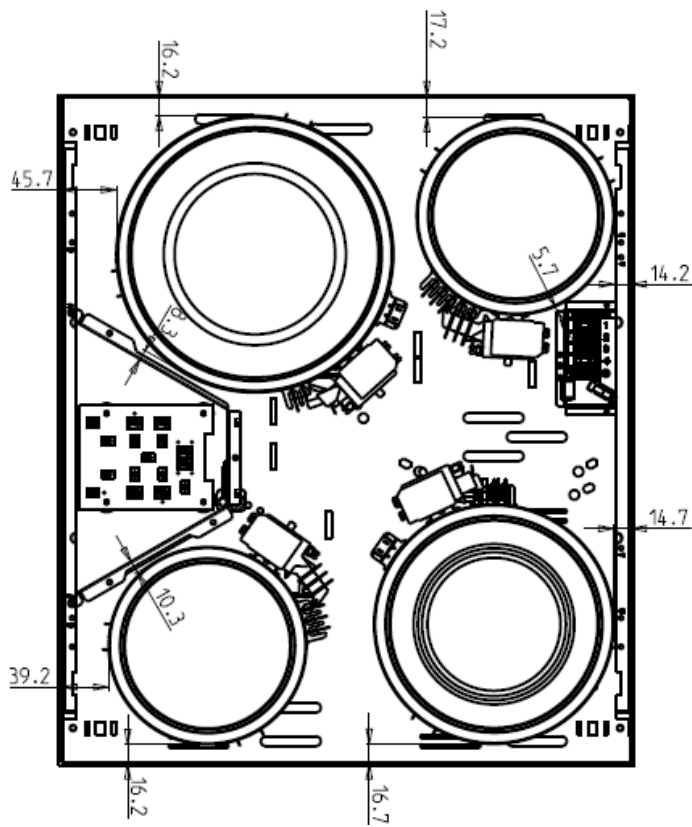
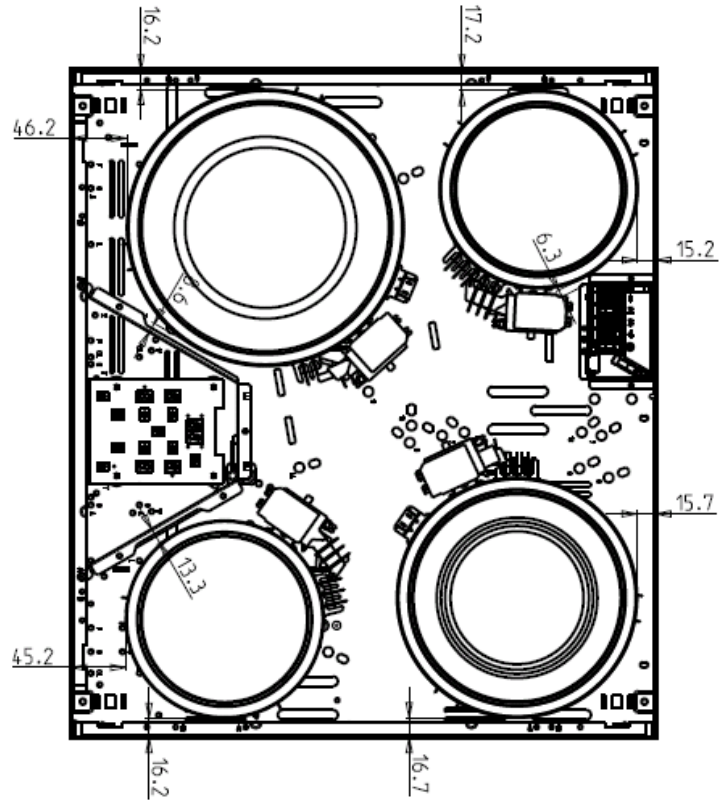

Comparison of normal dimension and slim dimension - ATTACHMENT

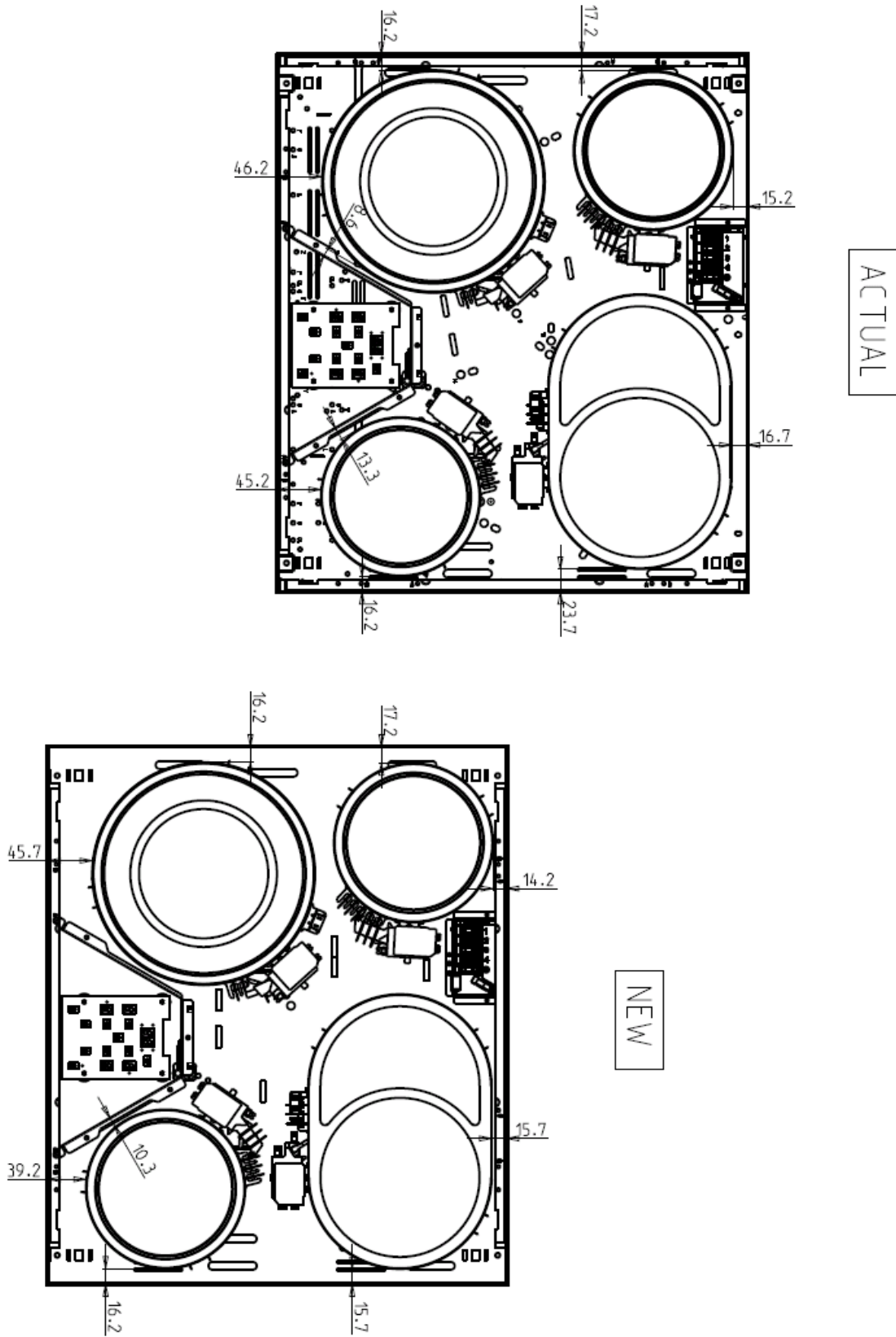

“ACTUAL” indicate normal dimension; “NEW” indicate slim dimension

PHOTOGRAPH - ATTACHMENT



Type P58..... Model RV6300 Front view



Type P58..... Model RV6300 Rear view

PHOTOGRAPH - ATTACHMENT



PHOTOGRAPH - ATTACHMENT

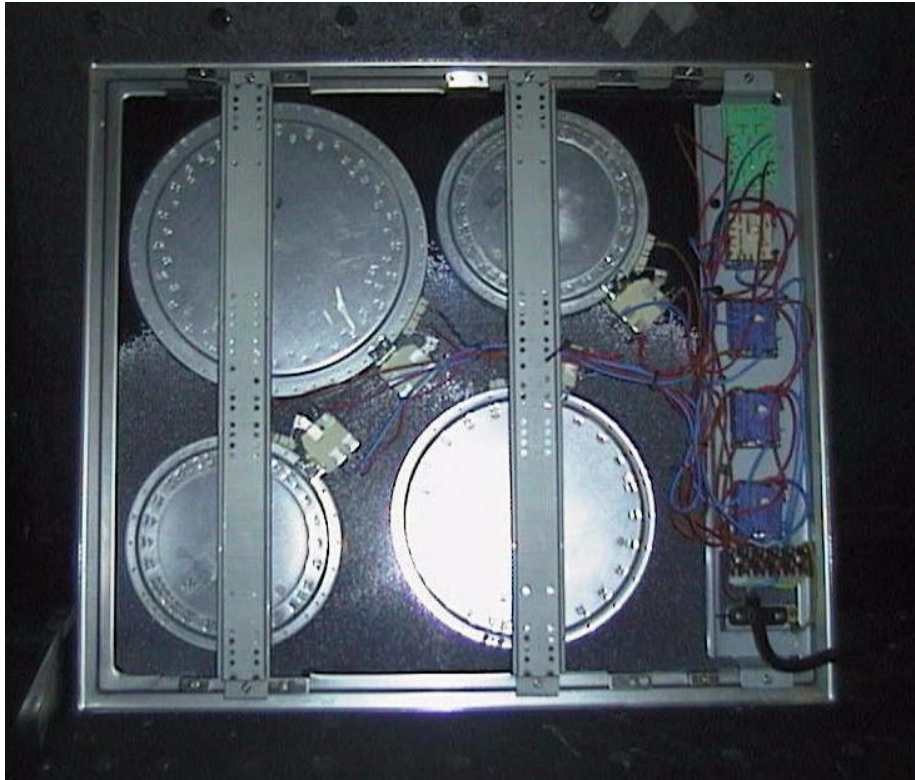

Type P58..... Model RV6300 Internal view

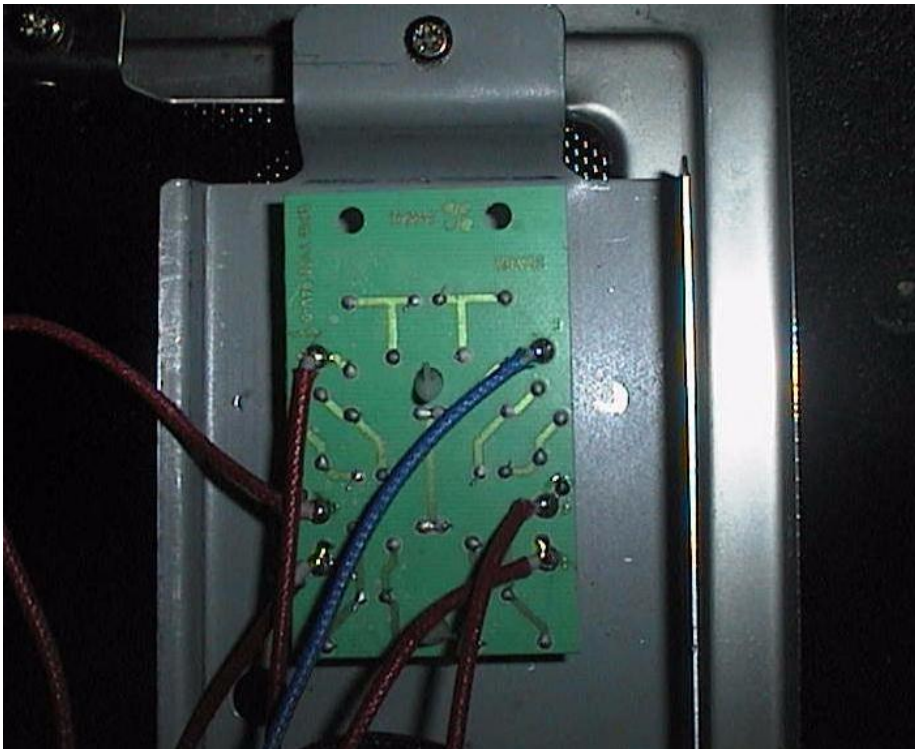

PHOTOGRAPH - ATTACHMENT

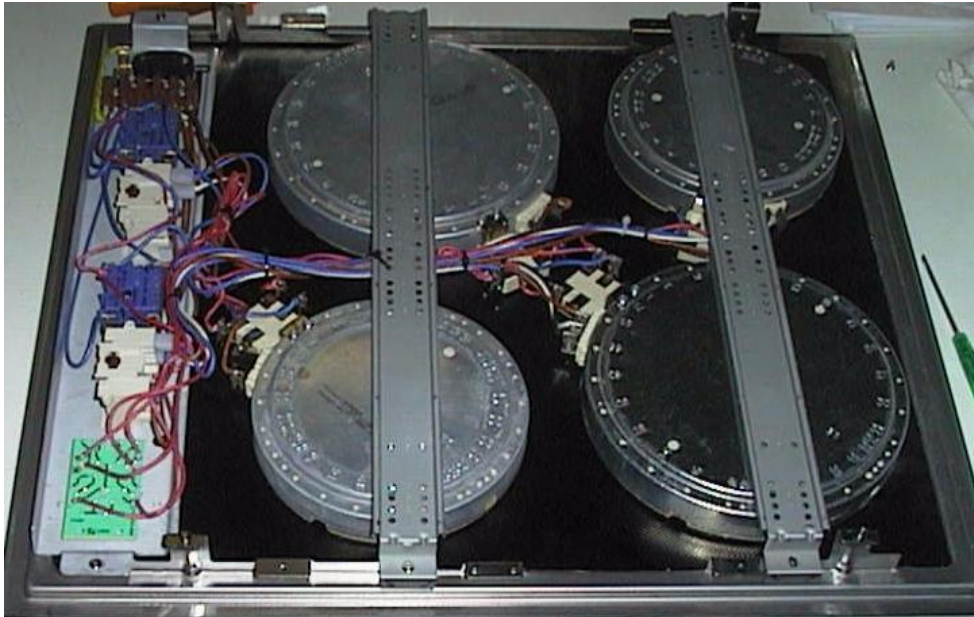

Type P58..... Model MV.... Internal view

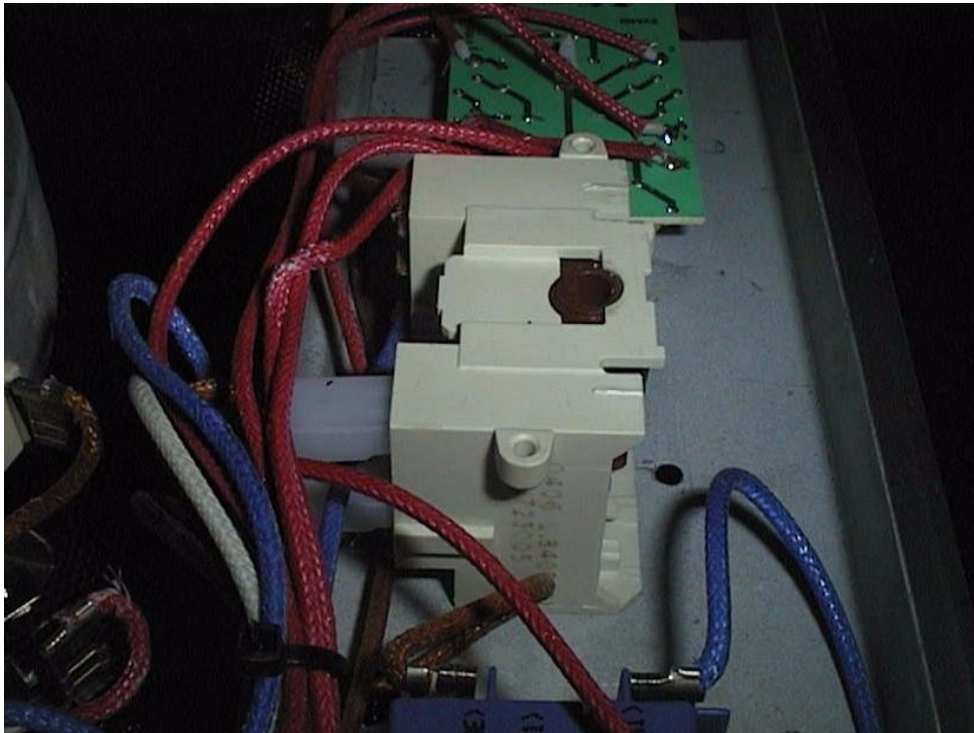

Type P58..... Model MV.... Switch

PHOTOGRAPH - ATTACHMENT

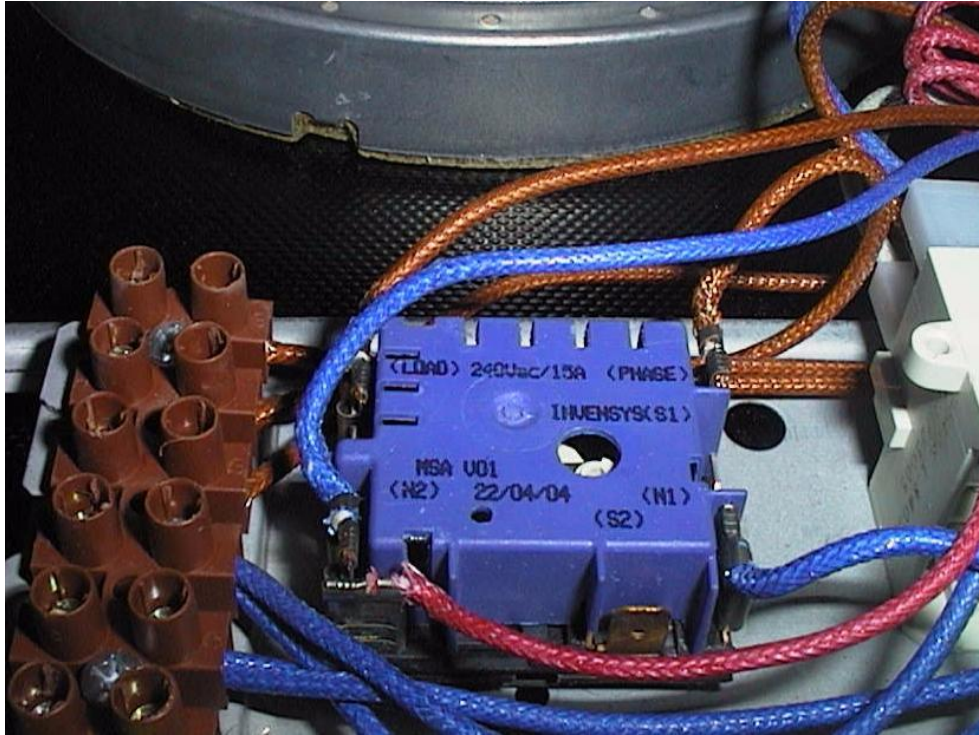

Type P58..... Model MV.... Energy regulator



Type P58..... Model EV6700 Front view

PHOTOGRAPH - ATTACHMENT

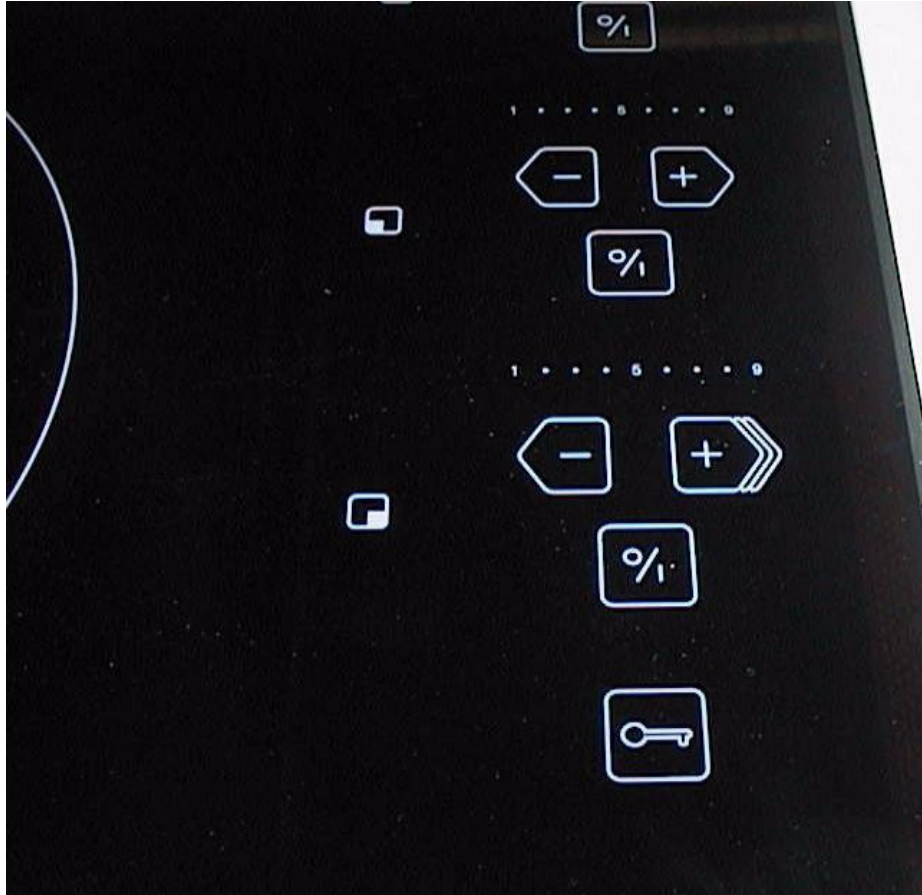

Type P58..... Model EV6700 Touch-tactile control



Type P58..... Model EV6700 Rear view

PHOTOGRAPH - ATTACHMENT



Type P58..... Model EV6700 Internal view

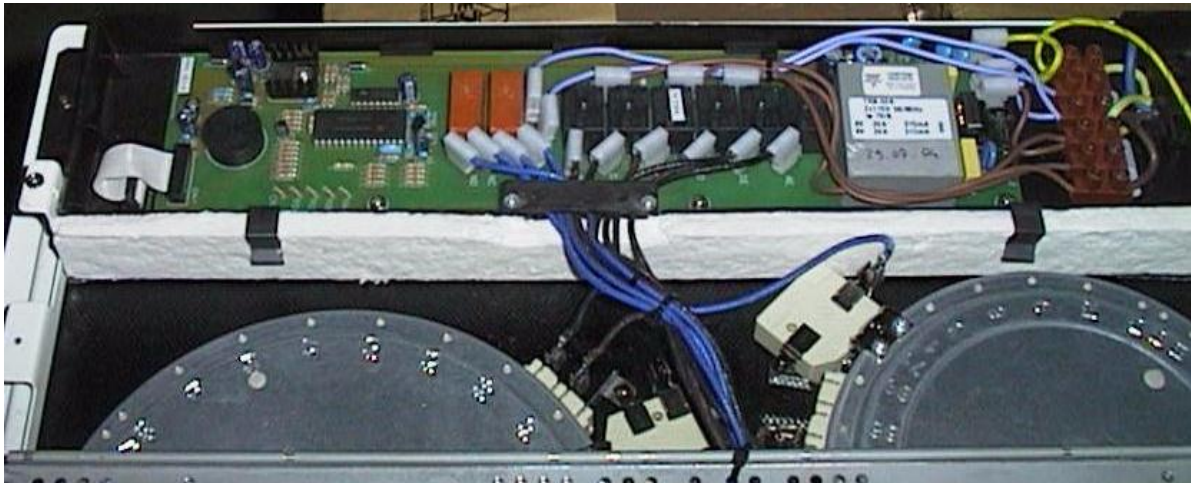

Type P58..... Model EV6700 Electronic PGA 9901.1E1

PHOTOGRAPH - ATTACHMENT

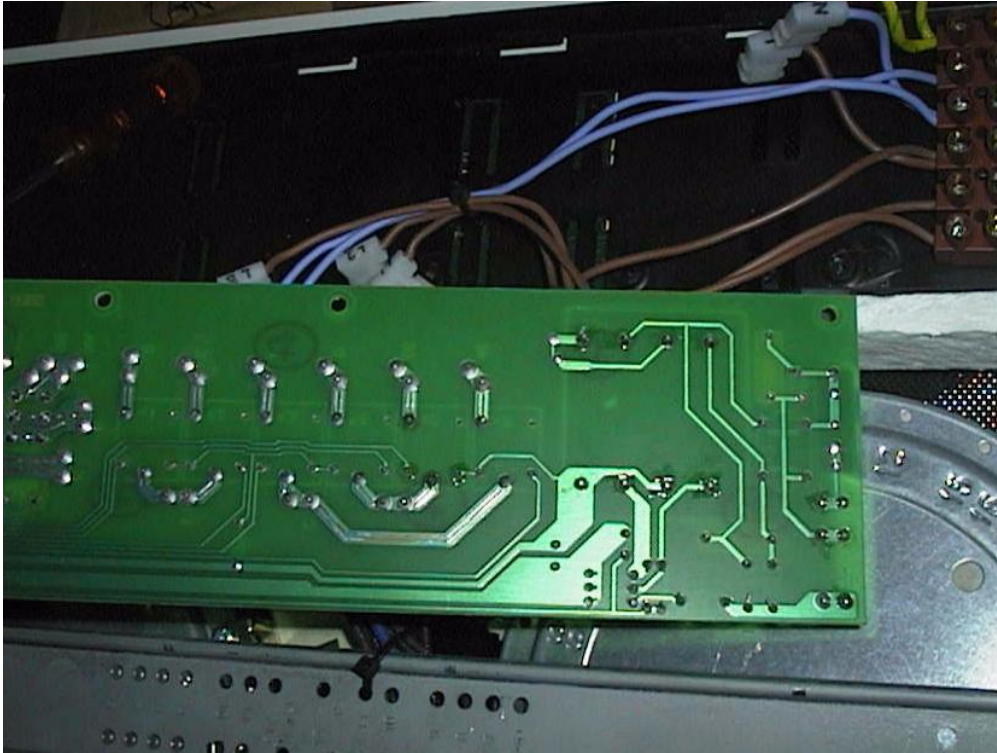

Type P58..... Model EV6700, Rear view of PCB, behind transformer



Type P58..... Model EO6700 Front view

PHOTOGRAPH - ATTACHMENT

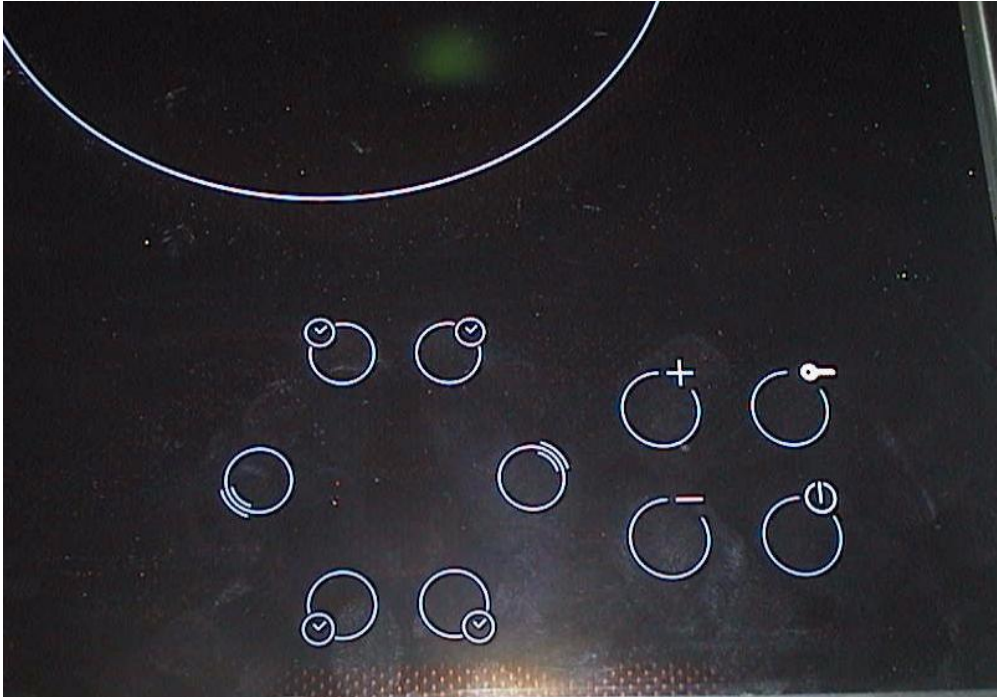

Type P58..... Model EO6700 Touch-touch control with timer



Type P58..... Model EO6700 Rear view

PHOTOGRAPH - ATTACHMENT

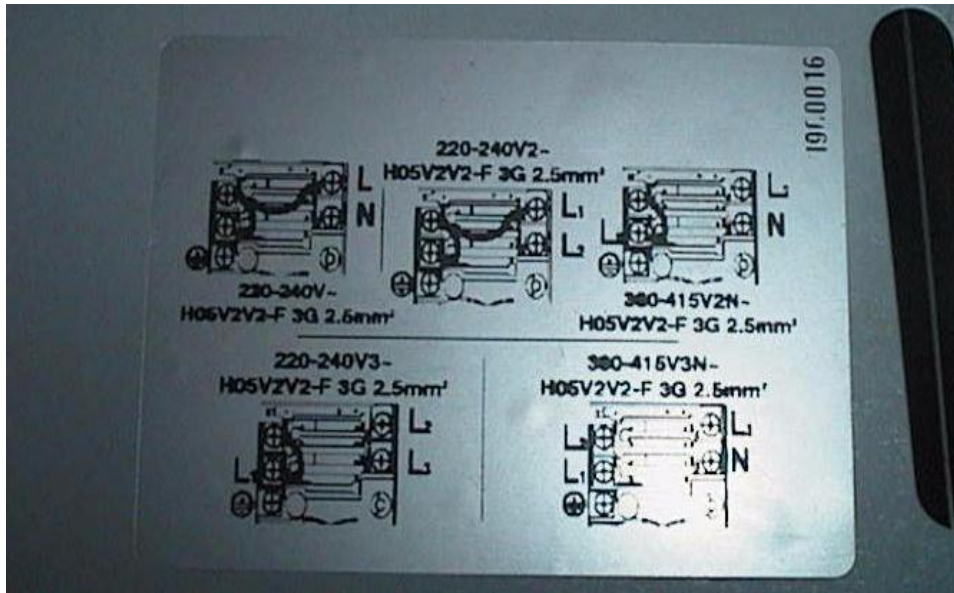

Type P58..... Model EO6700 Connection diagram next to terminals



Type P58..... Model EO6700 Terminal

PHOTOGRAPH - ATTACHMENT

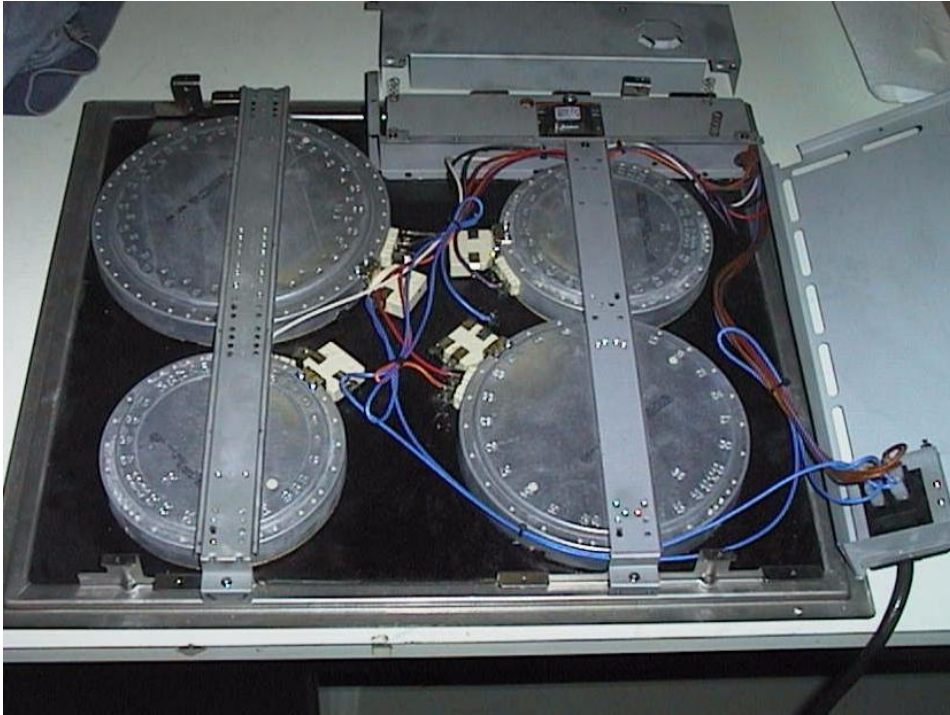

Type P58..... Model EO6700 Internal view

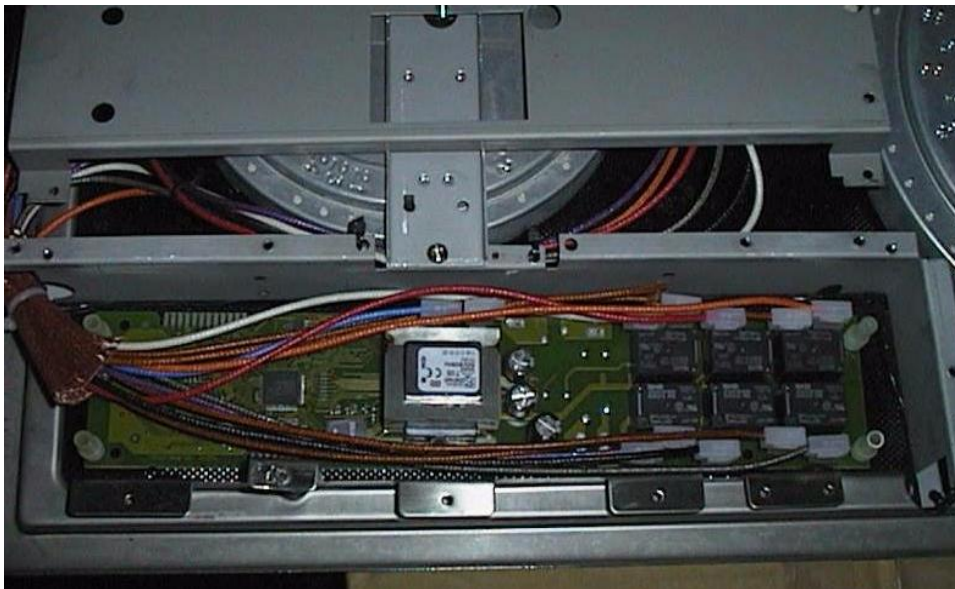

Rear of Touch control DIEHL 701453

PHOTOGRAPH - ATTACHMENT

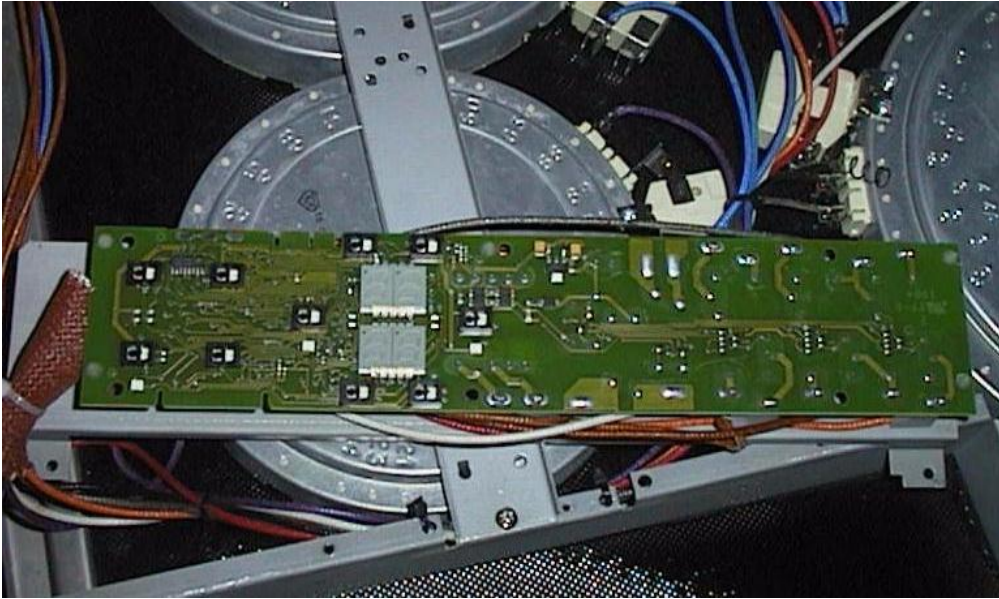

Front of Touch control DIEHL 701453 in contact with ceramic surface

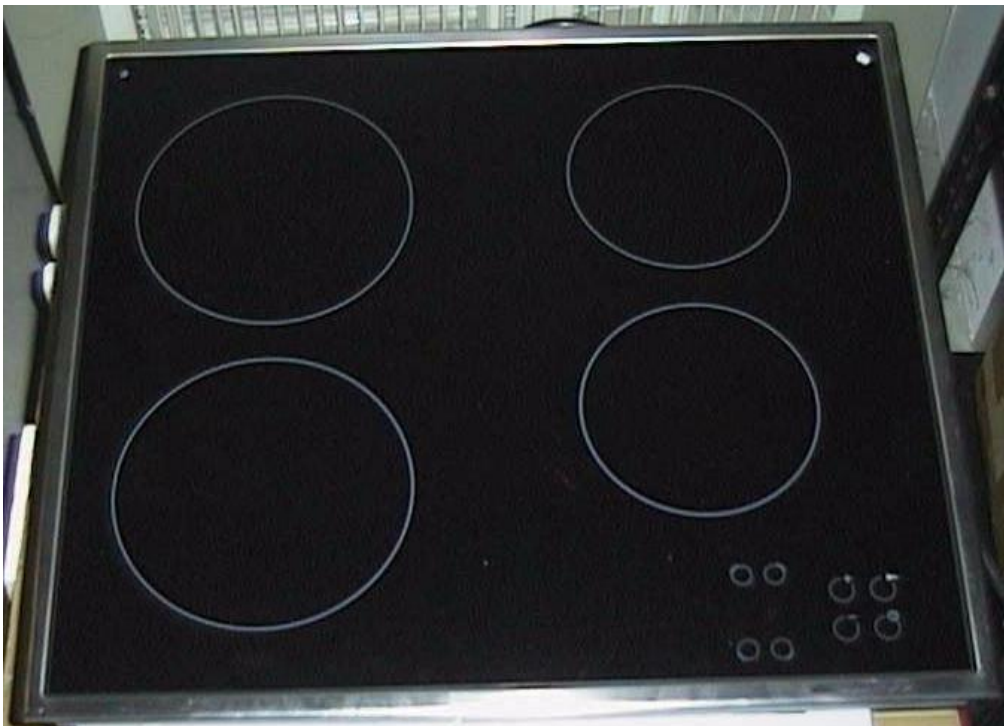

Type P58..... Model EO5900 Front view

PHOTOGRAPH - ATTACHMENT

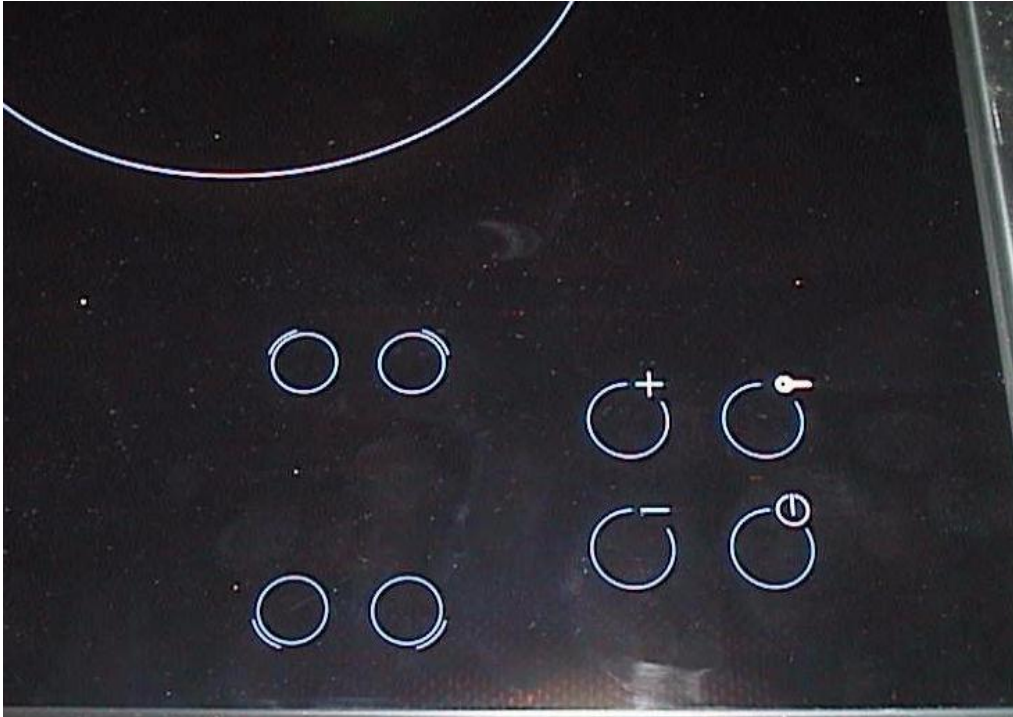

Type P58..... Model EO5900 Touch-touch control without timer



Rear of Touch-control EIKA

PHOTOGRAPH - ATTACHMENT



Transformer on EKA touch-control



Type P58..... Model EO6800 Front view

PHOTOGRAPH - ATTACHMENT



Type P58..... Model EO6800 Rear view



Type P58..... Model EO6900 internal overview

PHOTOGRAPH - ATTACHMENT

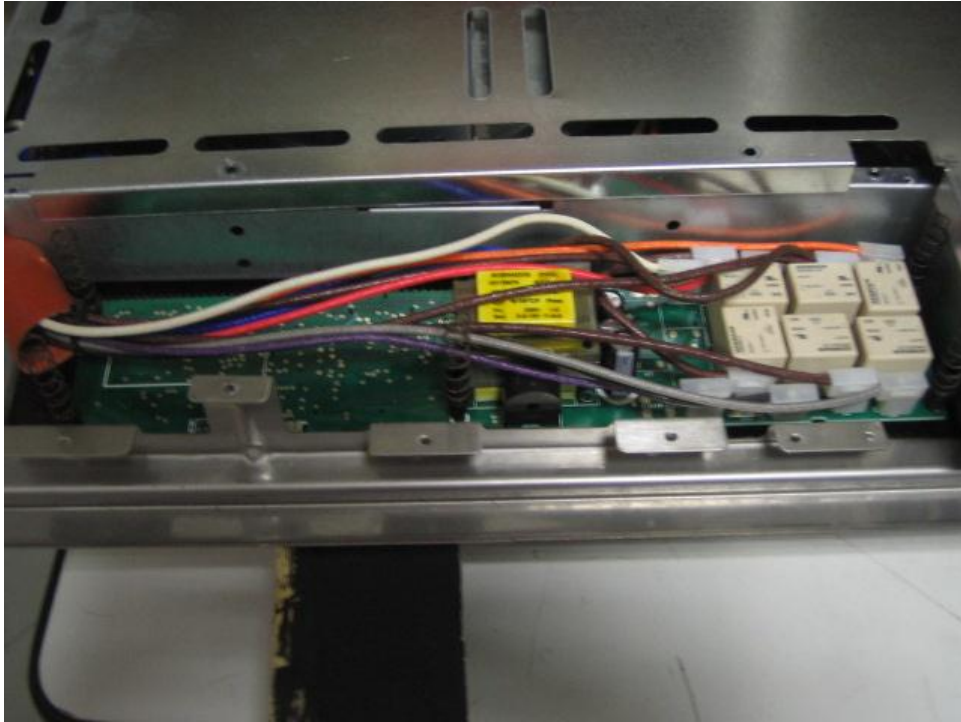

EIKA Electronic board



Transformer of EIKA electronic board

PHOTOGRAPH - ATTACHMENT



Relays on EIKA electronic board

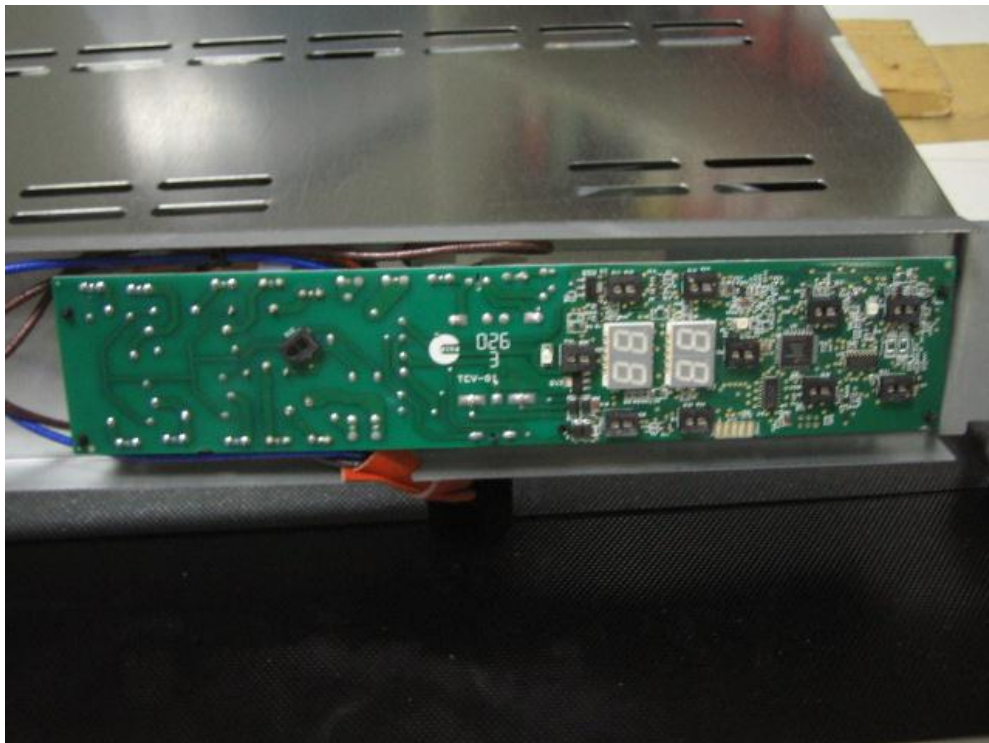

EIKA electronic board: display and touch control side.

PHOTOGRAPH - ATTACHMENT

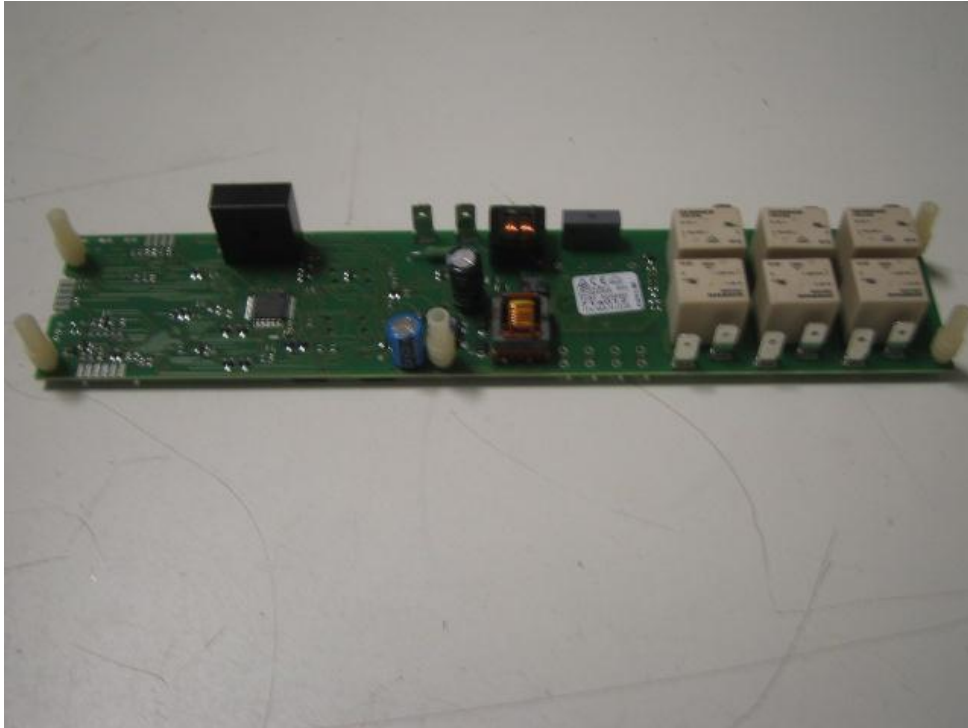

DIEHL electronic board

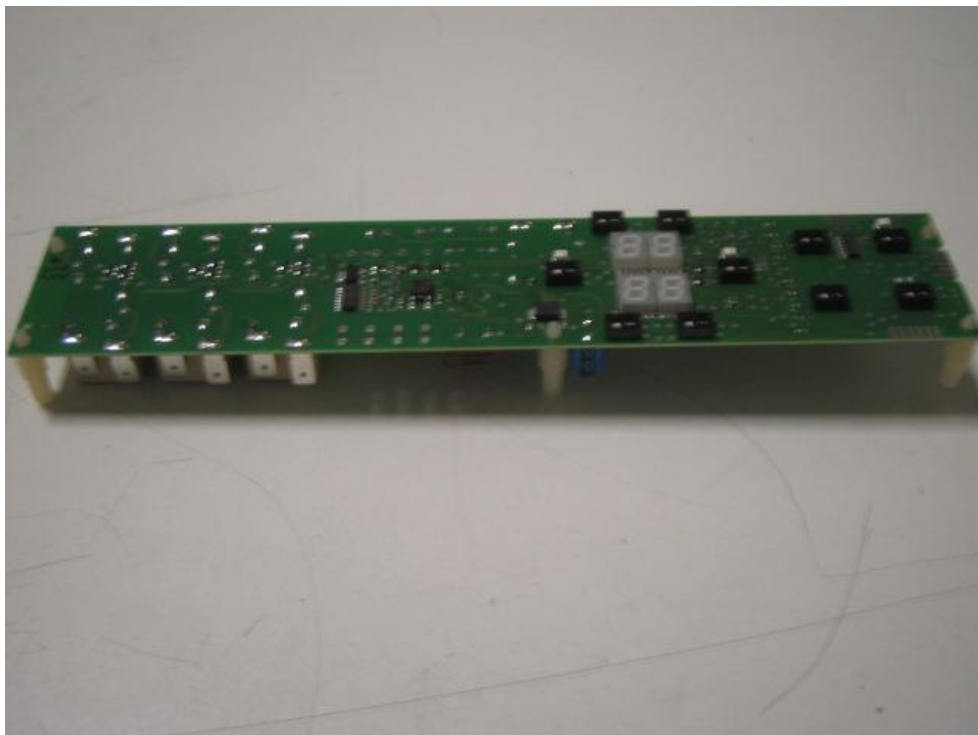

DIEHL electronic board: display and touch control side

PHOTOGRAPH - ATTACHMENT



DIEHL electronic board: transformer side.

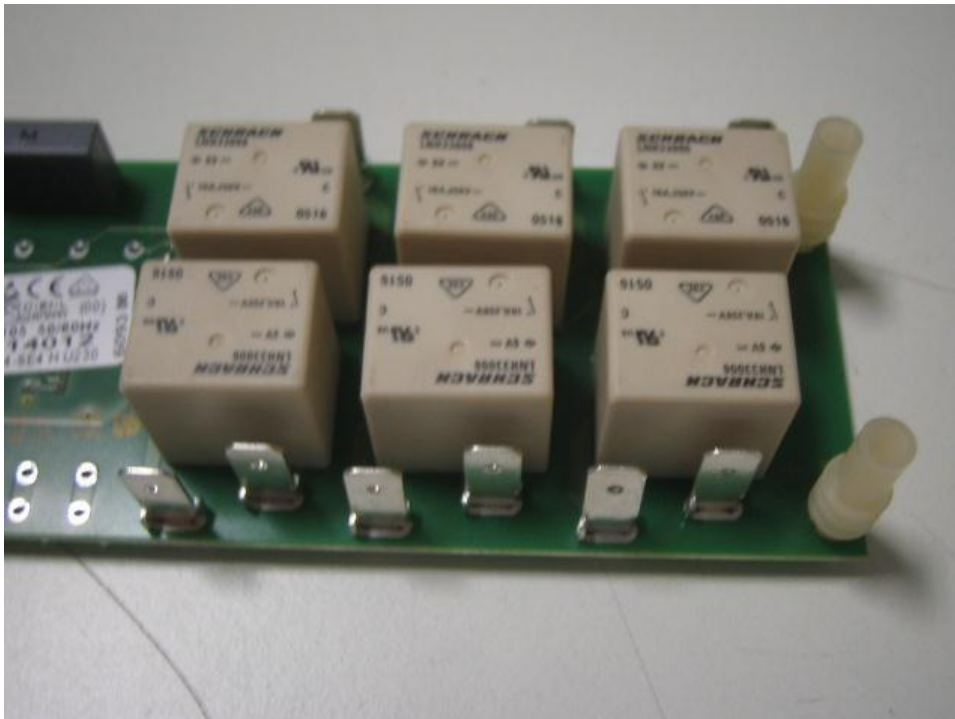

DIEHL electronic board: Relays.

PHOTOGRAPH - ATTACHMENT

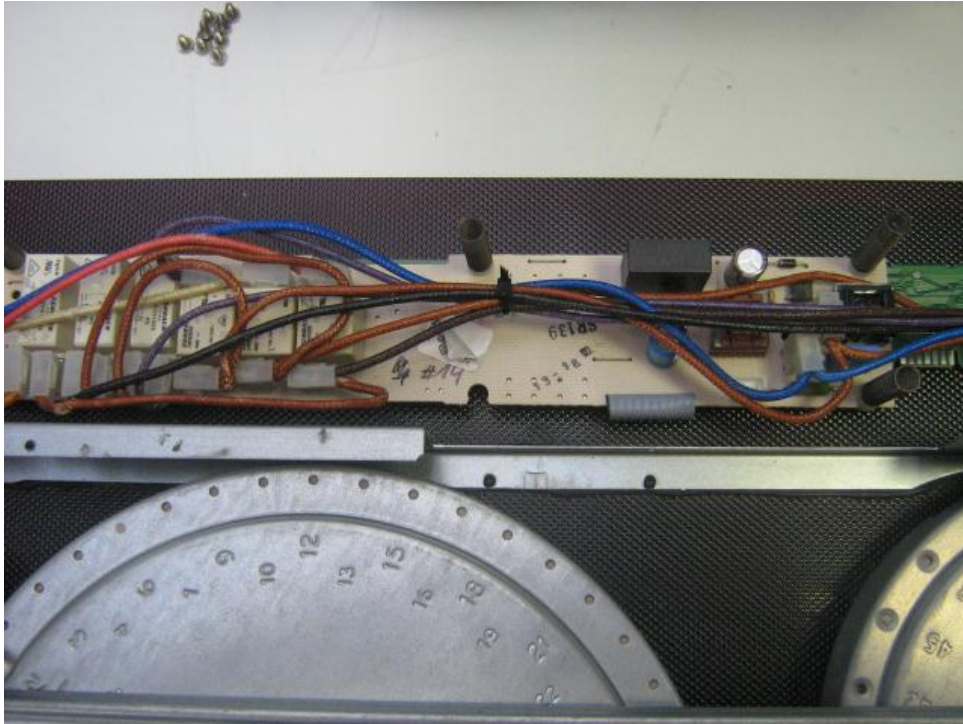

DIEHL electronic board: TC4 Standard H

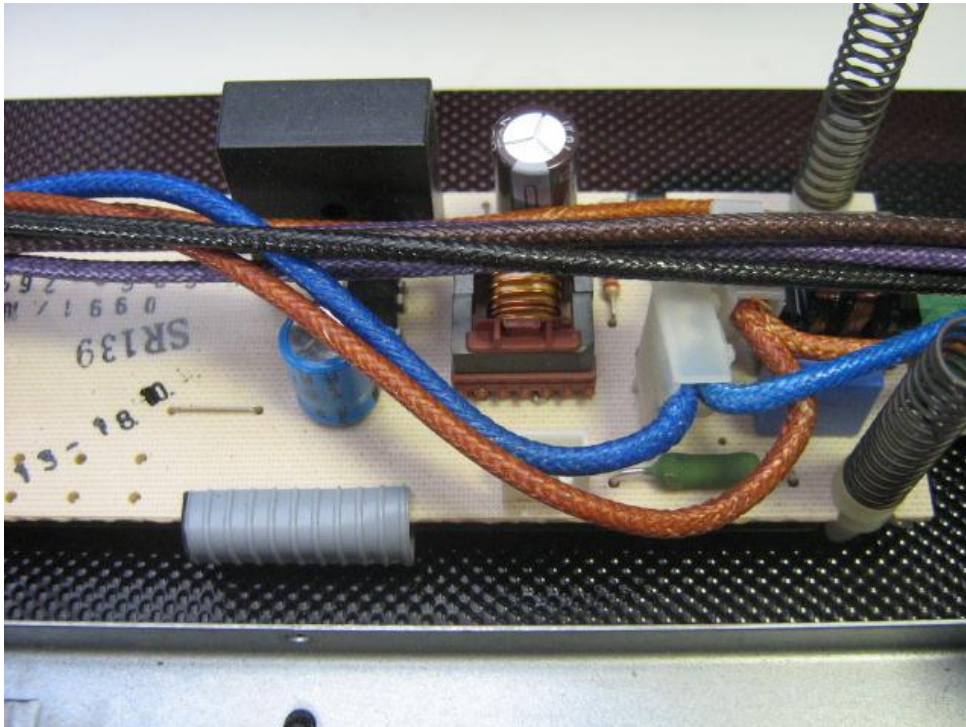

DIEHL electronic board: TC4 Standard H

PHOTOGRAPH - ATTACHMENT

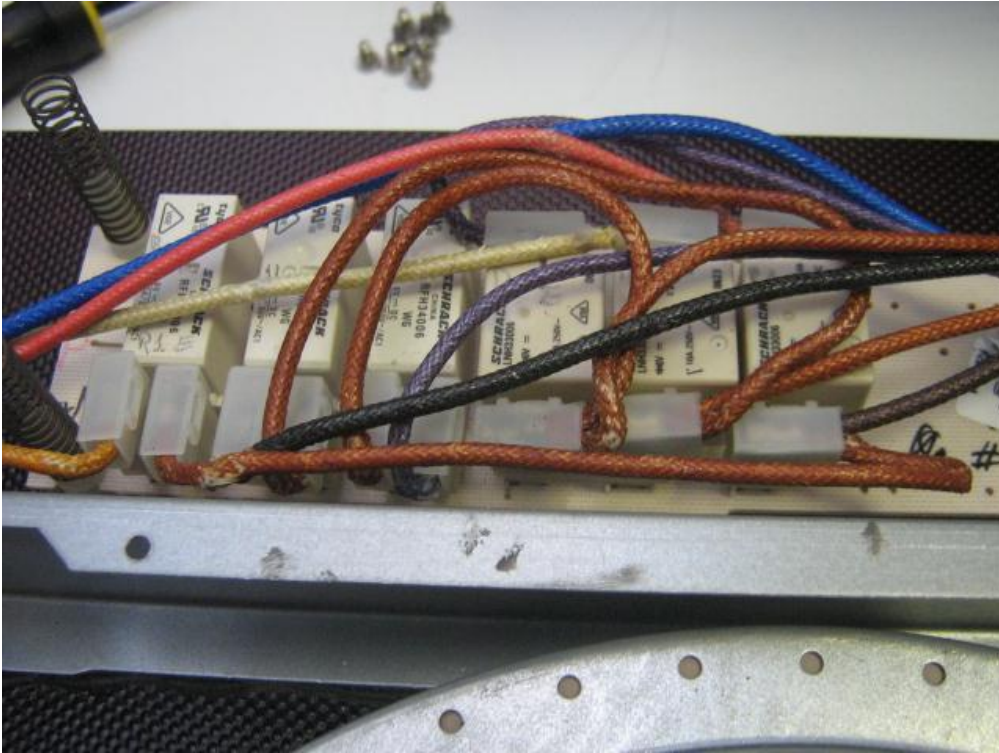

DIEHL electronic board: TC4 Standard H

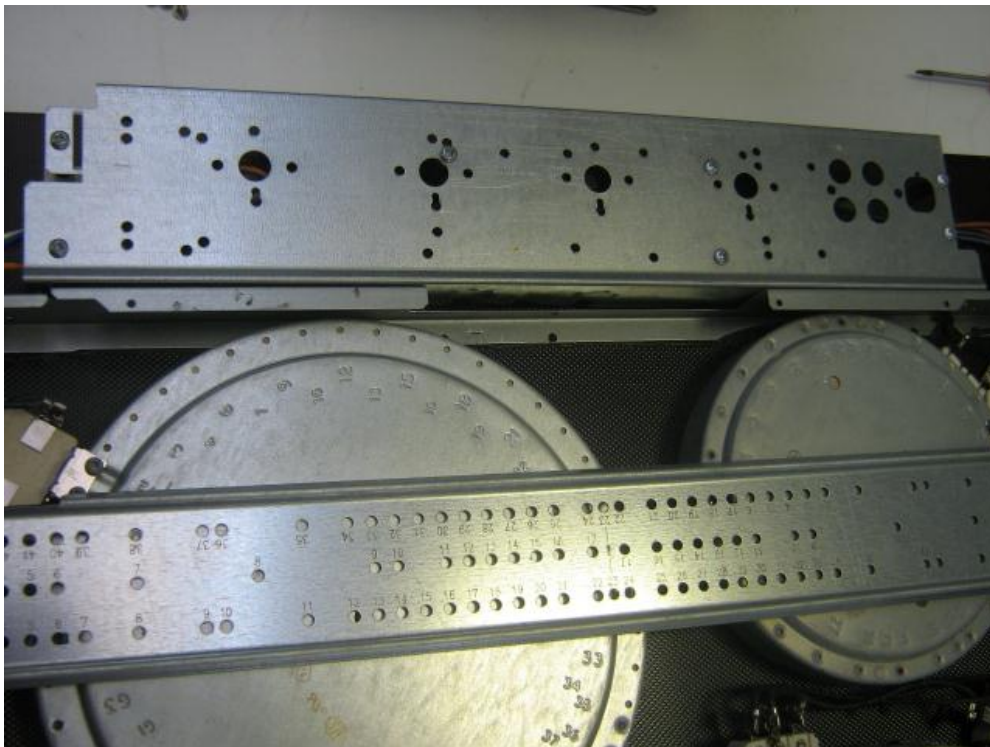

Metallic parts covering DIEHL electronic board: TC4 Standard H

PHOTOGRAPH - ATTACHMENT

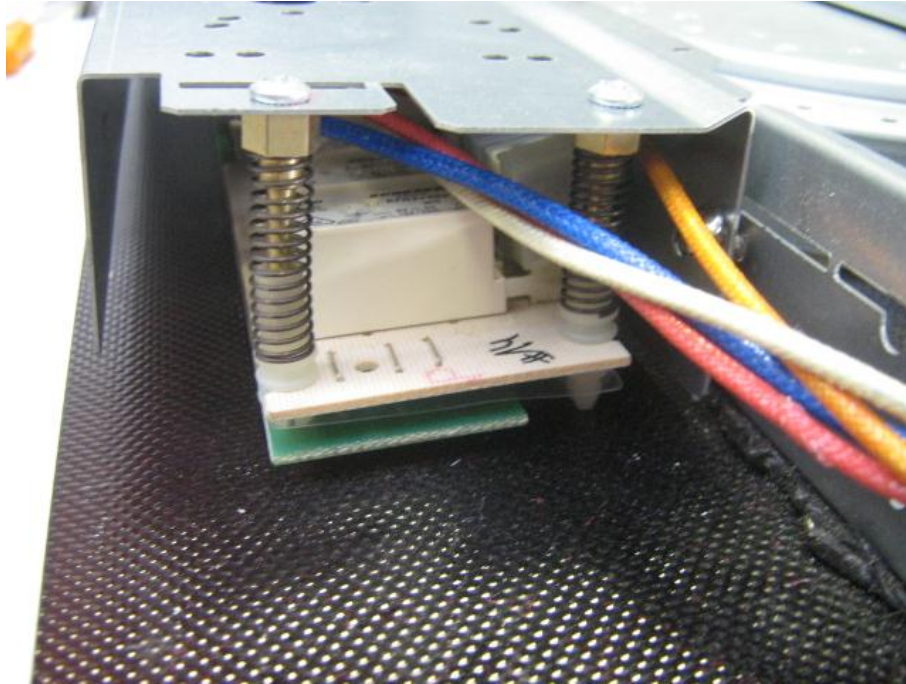

Positioning of DIEHL electronic board: TC4 Standard H inside the appliance

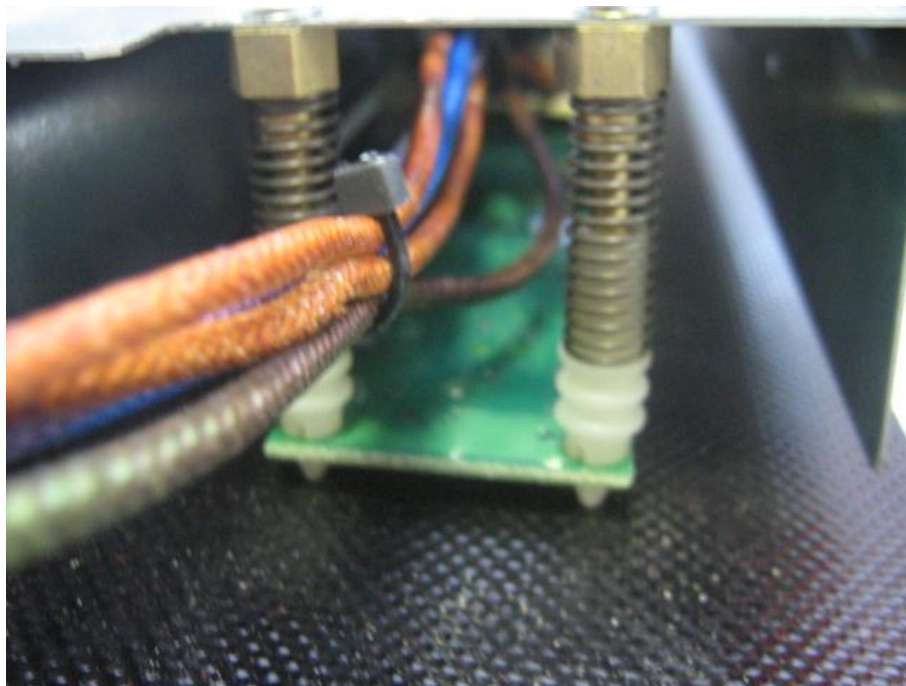

Positioning of DIEHL electronic board: TC4 Standard H inside the appliance

PHOTOGRAPH - ATTACHMENT

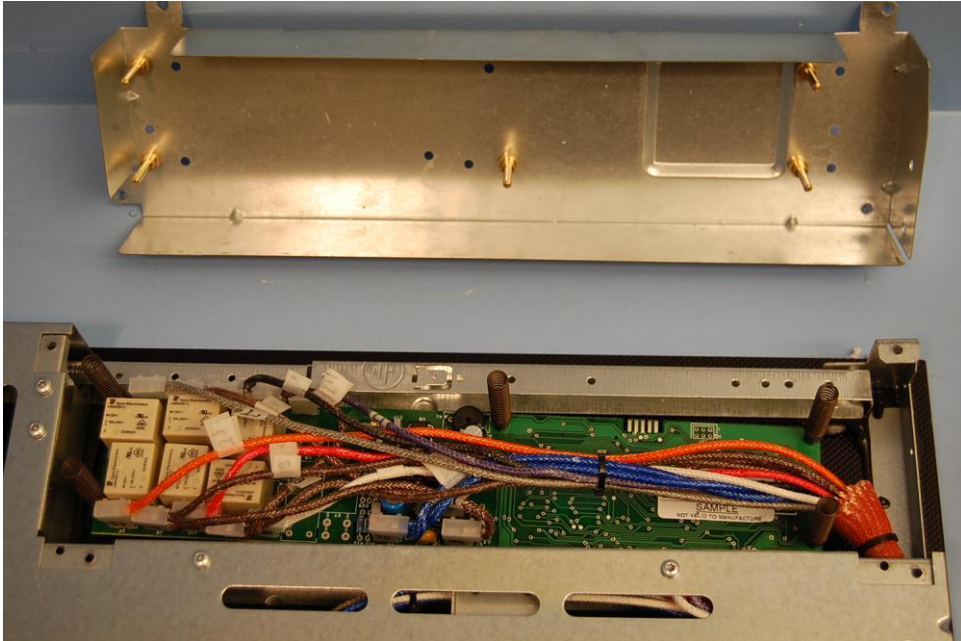

EIKA electronic board: BJ3xxA36211101in appliance



EIKA electronic board: BJ3xxA36211101

PHOTOGRAPH - ATTACHMENT

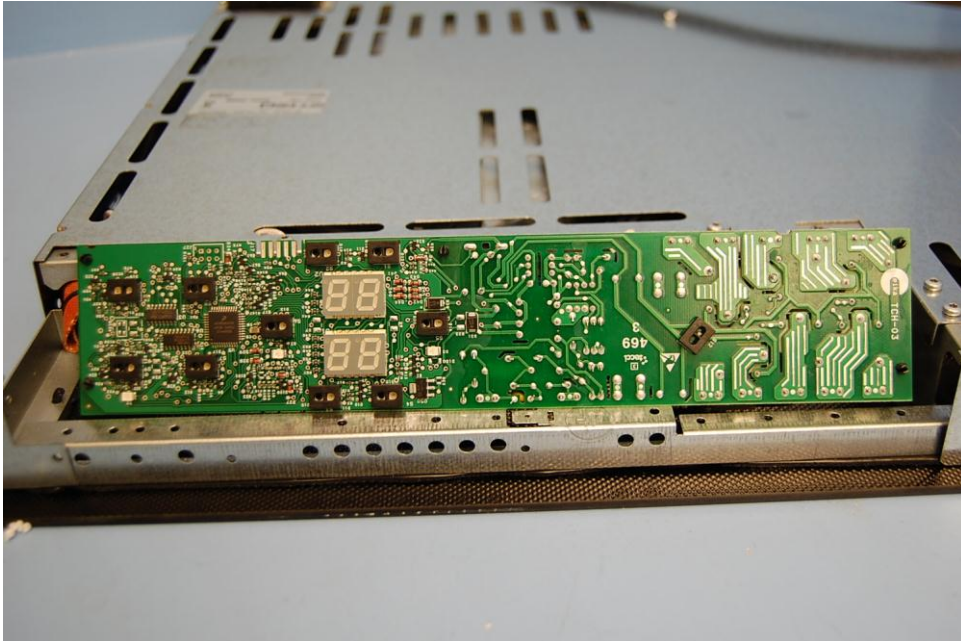

EIKA electronic board: BJ3xxA36211101

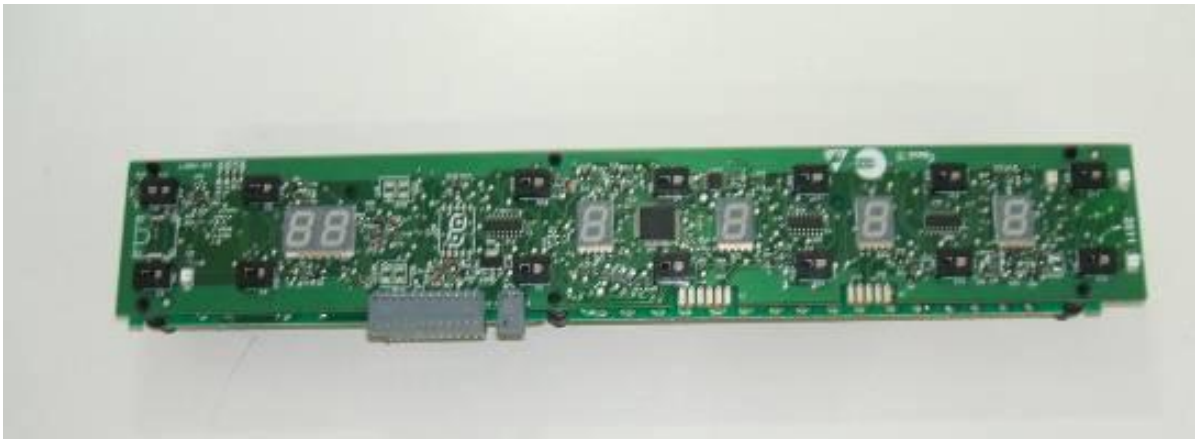

Eika BH3715360111xx

PHOTOGRAPH - ATTACHMENT

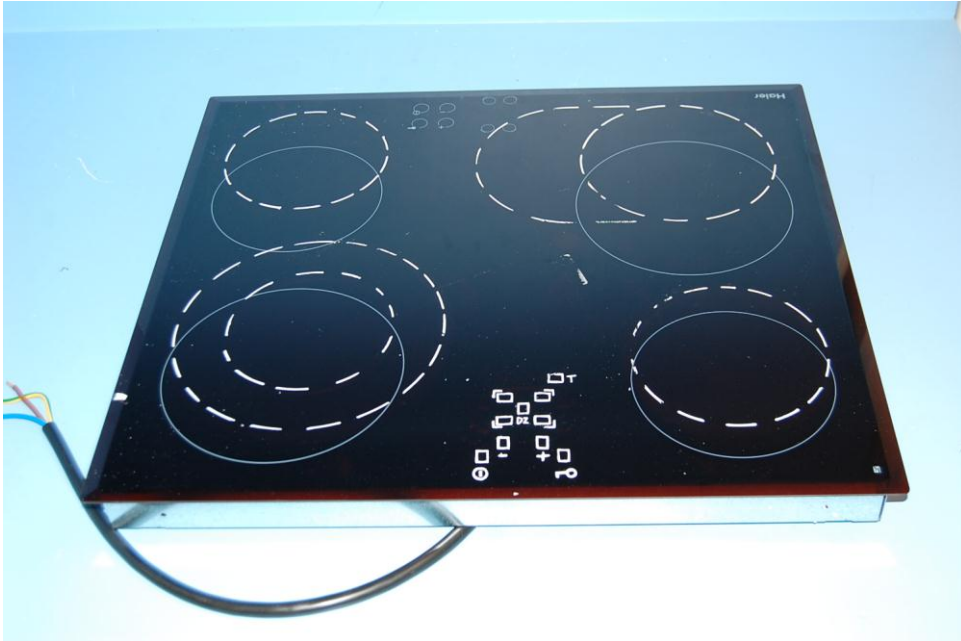

EC6700 (prototype)



EC5500 (prototype)

PHOTOGRAPH - ATTACHMENT

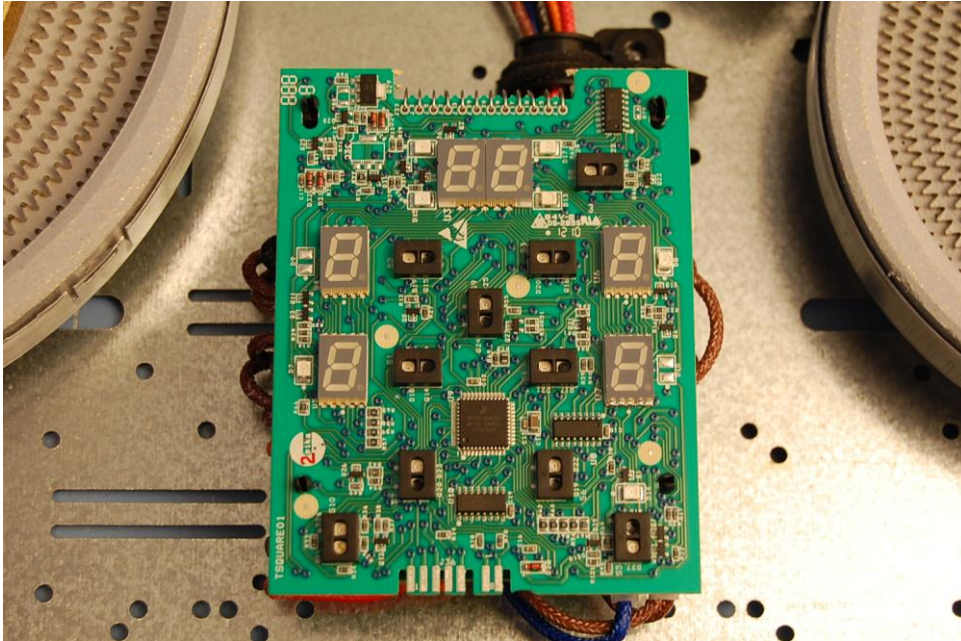

PCB control unit (touch & display board)

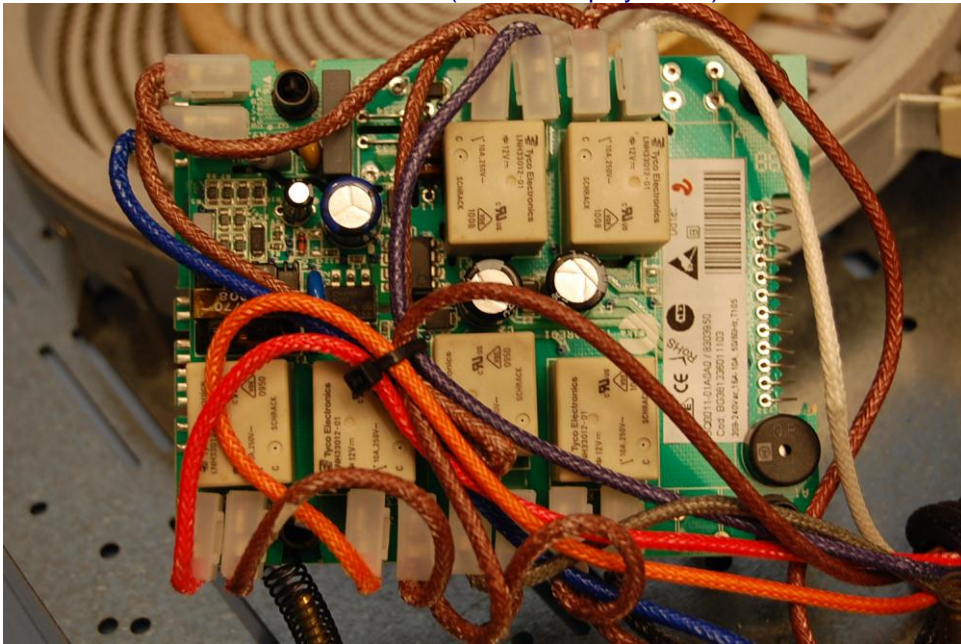

PCB control unit (Relay control board)

PHOTOGRAPH - ATTACHMENT

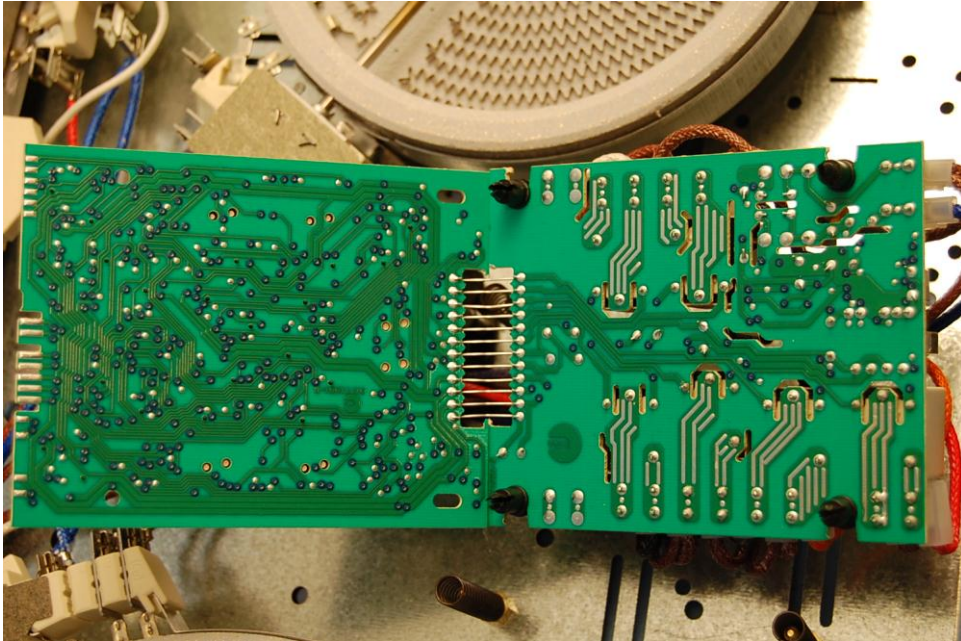

PCB control unit (rear side)

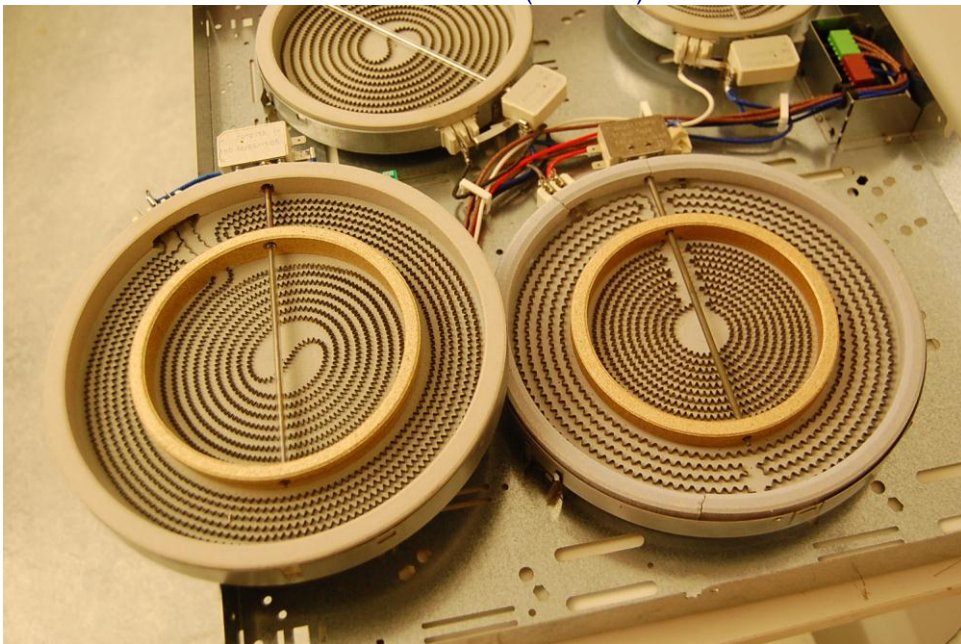

New heating element from **eika** (left) and **EGO** (right)

PHOTOGRAPH - ATTACHMENT

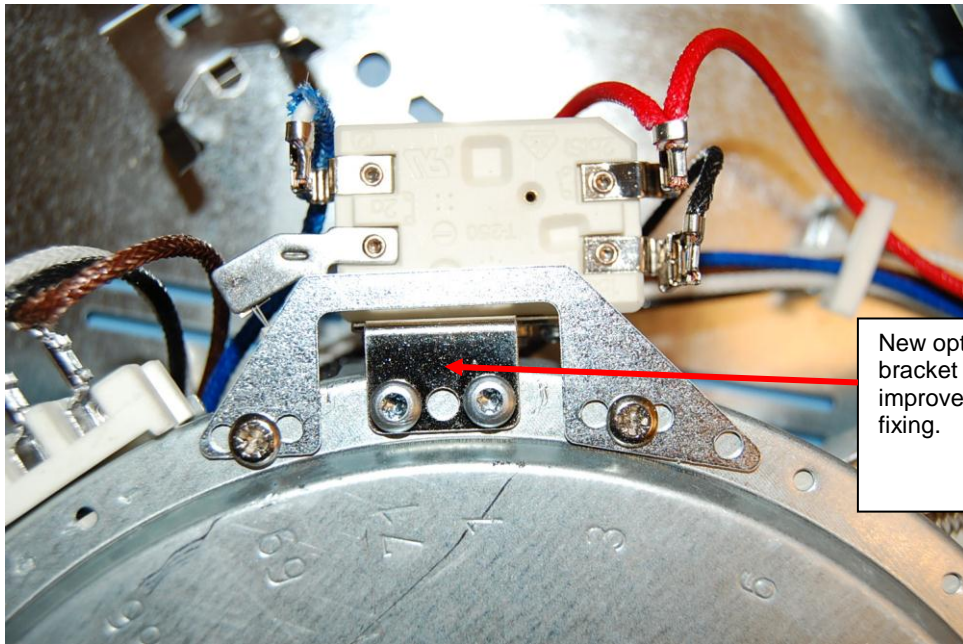

New optional bracket for improved fixing.

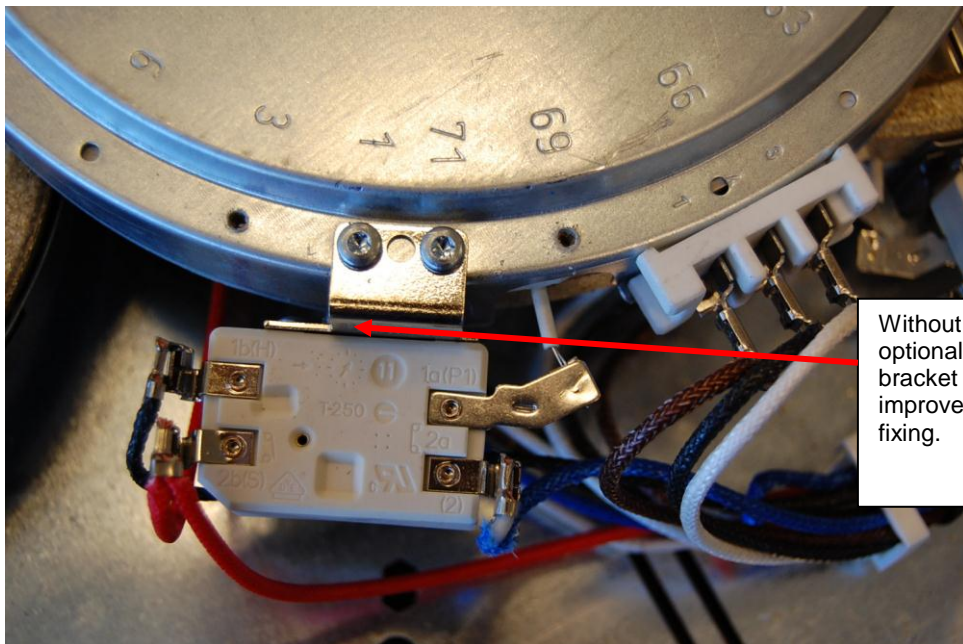

Without optional bracket for improved fixing.

PHOTOGRAPH - ATTACHMENT

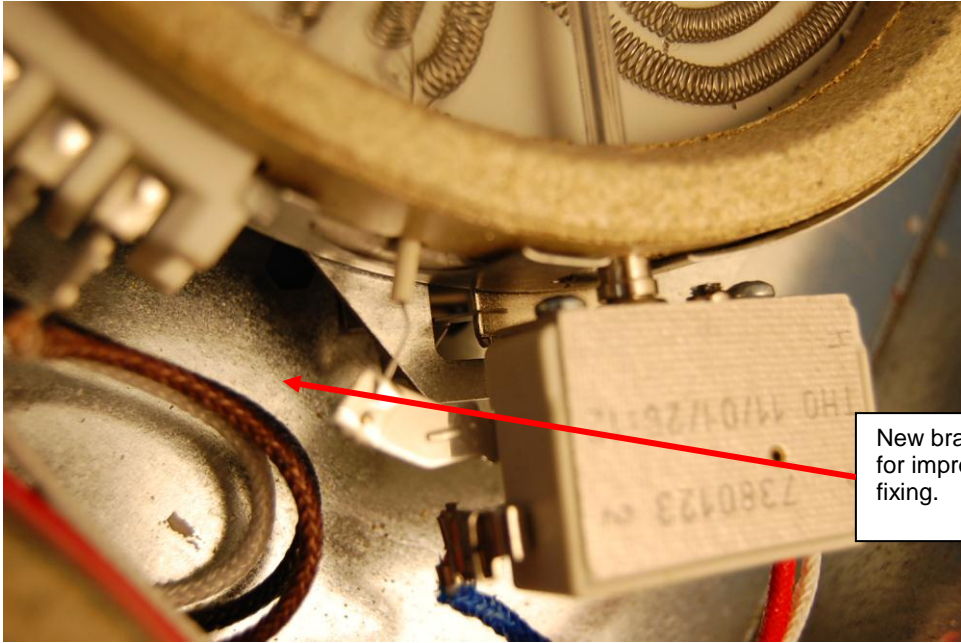

New bracket for improved fixing.

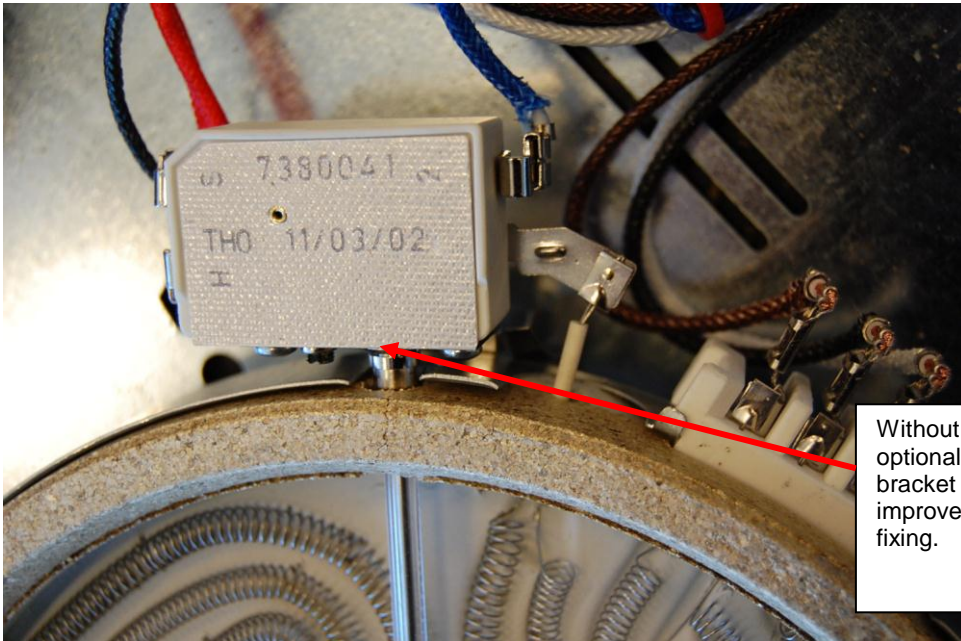

Without optional bracket for improved fixing.

PHOTOGRAPH - ATTACHMENT

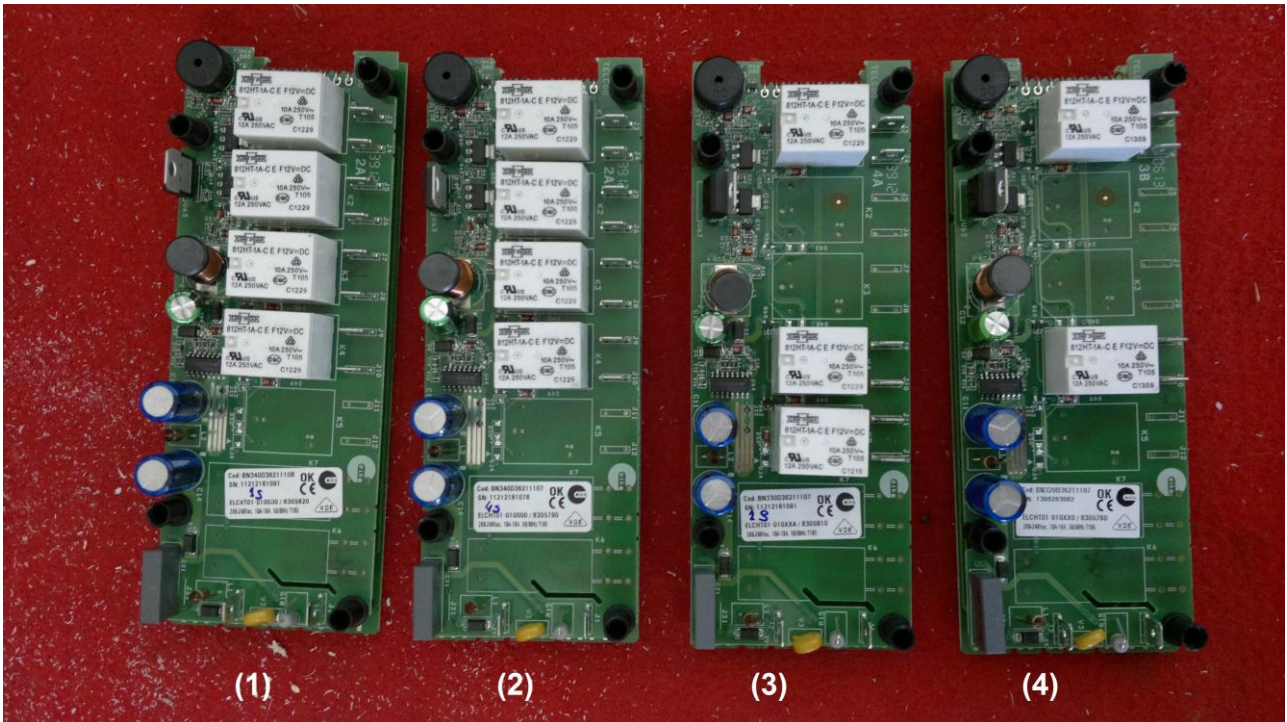

(1) BN340D3621110B (for P58, P75 only)
 (2) BN340D36211107 (for P58, P75 only)
 (3) BN330D36211107 (for P29 only)
 (4) BN320D36211107 (for P29 only)

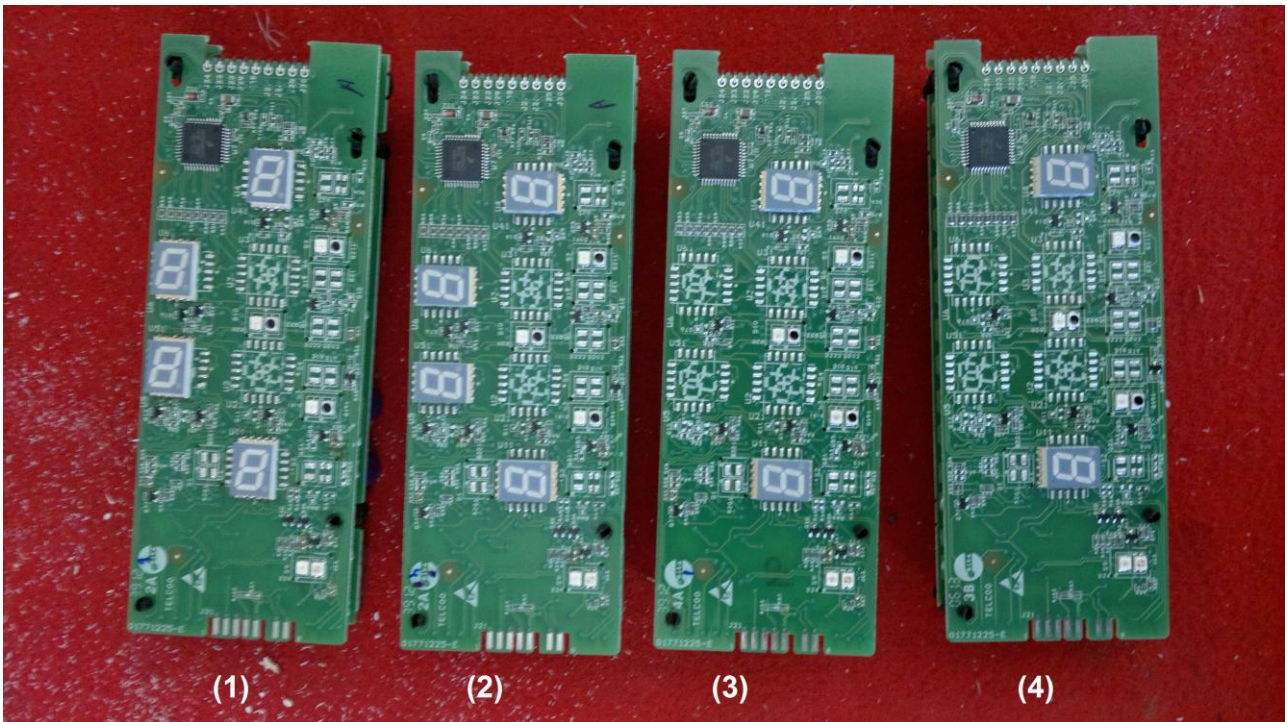

PHOTOGRAPH - ATTACHMENT



New control PCB BN340D36211107 in EO6400

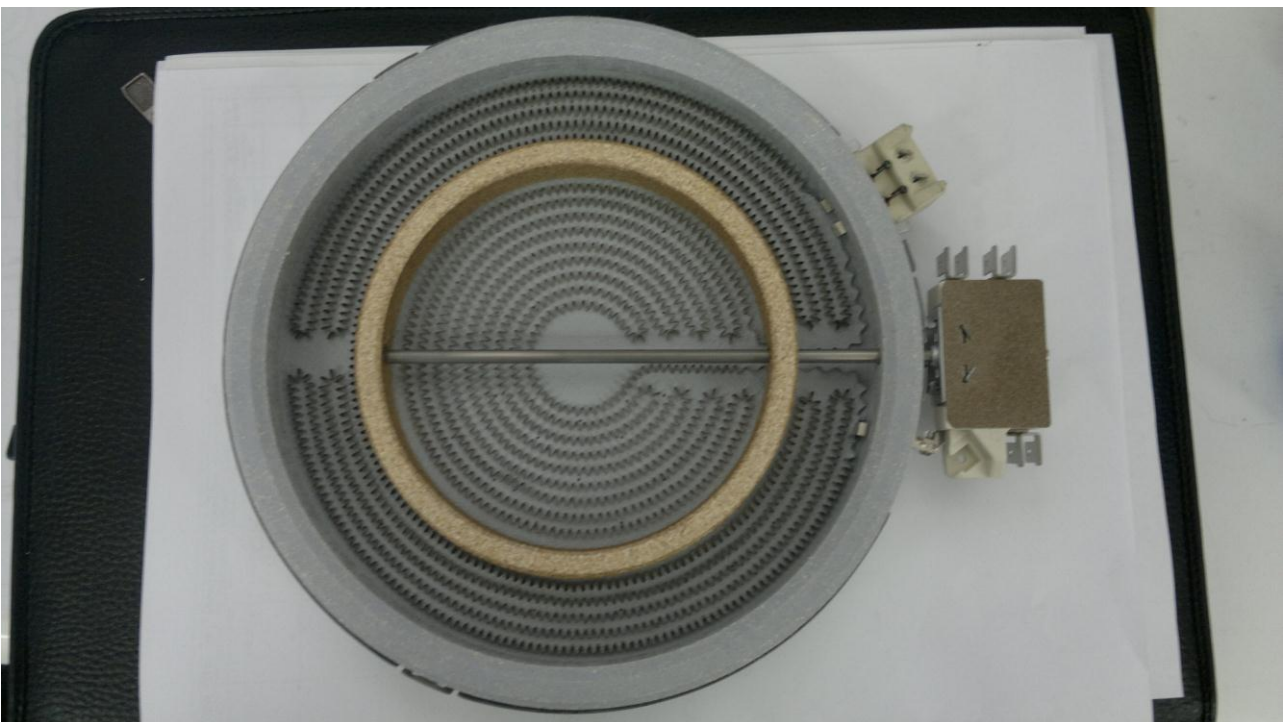

New heating element from E.G.O (10.58213.004)

COMPONENT LIST FOR ELECTRONIC CONTROL UNIT 3 - ATTACHMENT

Page 95 of 150

Report No.: VDE 846000-4520-0006/157788

24.1.1	TABLE: transformers supplying external SELV circuit			Verdict
	secondary winding tested	maximum output voltage (V)	maximum output current (A)	
	---	---	---	---
	---	---	---	---
	---	---	---	---
	---	---	---	---
	---	---	---	---

24.2	TABLE: components					
Object	Production Code	Manufacturer	Type / Model	Technical data	Standard	Mark(s) of conformity
Relay	1571548	Song Chuan	812HT-1A-C E F12V	AC250V,10A,105°C, 100k,cl. F	IEC 81810 IEC 60730-1 IEC 60335-1	within appl. and VDE 122905
Relay	1571539	Song Chuan	881WP2-1AC-F-C E 12	AC250V,16A,105°C, 30k,cl. F	IEC 81810 IEC 60730-1 IEC 60335-1	VDE 132905
Relay		Song Chuan	SG7	AC250 V, 10A, 105°C, 200k, cl.F	IEC 81810 IEC 60730-1 IEC 60335-1	VDE 40028040
Relay	1571561	TYCO(Schrack)	LNH3(0,3)012	AC250 V, 10A, 105°C, 300k, cl.F	IEC 81810 IEC 60730-1 IEC 60335-1	VDE 40004598
Relay	1571539	TYCO(Schrack)	RFH34012 WG	AC250 V, 16A, 105°C, 30k, cl.F	IEC 81810 IEC 60730-1 IEC 60335-1	VDE 40010110
Relay	1571561	Hongfa	HF152F-T-012-1HT	AC250 V, 10A, 105°C, 250k, cl.F	IEC 81810 IEC 60730-1 IEC 60335-1	VDE 40017837
Relay	1571561	Hongfa	HF152FD-012-1HQ	AC250 V, 10A, 105°C, 250k, cl. F	IEC 81810 IEC 60730-1 IEC 60335-1	VDE 40017837
Relay	1571539	Hongfa	HF115F-Q-012-1H	AC250 V, 16A, 105°C, 80k, cl.F	IEC 81810 IEC 60730-1 IEC 60335-1	VDE 116934
Relay		Hongfa	HF152FD-012-1H	AC250 V, 10A, 105°C, 250k, cl. F	IEC 81810 IEC 60730-1 IEC 60335-1	VDE 40017837
Relay		Hongfa	HF152F-T-012-1HTQ	AC250 V, 10A, 105°C, 250k, cl.F	IEC 81810 IEC 60730-1 IEC 60335-1	VDE 40017837
Varistor	1177584	Vishay BC-Components	2381 59 .2716 2322 59 .2716	275V, ø7 mm , 125°C	IEC60730-1/-2-11 IEC60335-1/-2-6	VDE 40002622 and within appl.
Varistor	1177584	Joyin	JRV07N431K65	275V, ø7 mm , 125°C	IEC60730-1/-2-11 IEC60335-1/-2-6	VDE 5937UG and within appl

COMPONENT LIST FOR ELECTRONIC CONTROL UNIT 3 - ATTACHMENT

Page 96 of 150

Report No.: VDE 846000-4520-0006/157788

Sensor PCB	1771225	KINGBOARD	TELC	CI STH CEM3 1.6mm	IEC60730-1/-2-11 IEC60335-1/-2-6	within appliance
Sensor PCB	1771225	DOOSAN	TELC	CI STH CEM1 1.6mm	IEC60730-1/-2-11 IEC60335-1/-2-6	within appliance
Sensor PCB	1771225	Shengyi	TELC	CI STH CEM1 1.6mm	IEC60730-1/-2-11 IEC60335-1/-2-6	within appliance
Sensor PCB	1771225	Fagor Electrónica	TELC	CI FR-4 1.6mm	IEC60730-1/-2-11 IEC60335-1/-2-6	within appliance
Sensor PCB	1771225	Fagor Electrónica	TELC	CI CEM3 1.6mm	IEC60730-1/-2-11 IEC60335-1/-2-6	within appliance
Thermistor	1178023	Vishay BC-Components	2381 861 x.1413 2322 861 x.1413	140°C, max. 265V, 29R	IEC60730-1/-2-11 IEC60335-1/-2-6	within appliance
Safety Resistor	1178035	BIOHMSA	KFA 412 100R 5% ENC	Wire Wound 3W	IEC60730-1/-2-11 IEC60335-1/-2-6	within appliance
Safety Resistor	1178035	BIOHMSA	FMF 100R 5% 4.2x11.2	P.Metal 2W	IEC60730-1/-2-11 IEC60335-1/-2-6	within appliance
Safety Resistor	1171703	AC03 3W	VISHAY	Wire Wound 3W	IEC60730-1/-2-11 IEC60335-1/-2-6	within appliance
Safety Resistor	1175019	ULW2 100R	WELWYN	Wire Wound 2W	IEC60730-1/-2-11 IEC60335-1/-2-6	within appliance
Safety Resistor	1175019	ULW3 100R	WELWYN	Wire Wound 3W	IEC60730-1/-2-11 IEC60335-1/-2-6	within appliance
Safety Resistor	1175019	EMC2 68R	WELWYN	Wire Wound 2W	IEC60730-1/-2-11 IEC60335-1/-2-6	within appliance
SMPS Controller	1478626	Fairchild	FSDH0265RN	650vBVdss 100kHz 13W TO 265Vac	IEC60730-1/-2-11 IEC60335-1/-2-6	within appliance
SMPS Controller	1479724	Fairchild	FSQ0370	700vBVdss 100kHz 13W TO 265Vac	IEC60730-1/-2-11 IEC60335-1/-2-6	within appliance
X2 Capacitor	1078986	ARCOTRONIC	Serie R46 R46K13100JEM1M	100nF X2 110°C	IEC60384-14	IMQ (ENEC) V4413
X1 Capacitor	1078986	Vishay Röderstein	Serie F1710	100nF X1 110°C	IEC60384-14	VDE 136954L
X2 Capacitor	1078986	Vishay BC- Components	Serie E12 MKP339	100nF X2 110°C	IEC60384-14	SGS (ENEC) FI 2008038
X2 Capacitor	1070162	ISKRA	Serie KNB1560 0,1uF 275Vac 110°C	100nF X2 110°C	IEC60384-14	VDE
X2 Capacitor	1070162	Vishay BC- Components	Serie E12 MKP339T	100nF X2 125°C	IEC60384-14	SGS (ENEC) FI 2008071
X2 Capacitor	1070162	Arcotronics	Serie R46 R46K13100JEH1M	100nF X2 125°C	IEC60384-14	IMQ (ENEC) CA08.00063
X2 Capacitor	1070162	ISKRA	Serie KNB1560 0,1uF 275Vac 125°C	100nF X2 125°C	IEC60384-14	VDE
Buzzer	1571494	PKM13EPYH4000-A0	Murata	70dB 4kHz, 30Vdc p-p	IEC60730-1/-2-11 IEC60335-1/-2-6	within appliance
Buzzer	1571494	KPE-168TR	Kingstate	70dB 4kHz, 30Vdc p-p	IEC60730-1/-2-11 IEC60335-1/-2-6	within appliance
Faston	(Tab)	Micomp	671089	Tin plated copper alloys (Cu Zn 33 H13)	IEC60730-1/-2-11 IEC60335-1/-2-6	within appliance
Micro controller	1474069	FREESCALE	HCS08	MCU 8 bits 125°C	IEC60730-1/-2-11 IEC60335-1/-2-6	within appliance
Faston	671089	Micomp		Tin plated copper alloys (Cu Zn 33 H13)	IEC60730-1/-2-11 IEC60335-1/-2-6	within appliance

COMPONENT LIST FOR ELECTRONIC CONTROL UNIT 3 - ATTACHMENT

Page 97 of 150

Report No.: VDE 846000-4520-0006/157788

Viper		ST Microelectronics	ViperTm plus family	AC265 V 150°C	IEC60730-1/-2-11 IEC60335-1/-2-6	within appliance
MSS1260		Coilcraft	SMT Power inductor	125°C ClassB	IEC60730-1/-2-11 IEC60335-1/-2-6	within appliance
MSS1260T		Coilcraft	SMT Power inductor	155°C ClassH	IEC60730-1/-2-11 IEC60335-1/-2-6	within appliance
RFB serie		Coilcraft	Power inductor	125°C ClassB	IEC60730-1/-2-11 IEC60335-1/-2-6	within appliance
SL Serie		Chilisin/ELCO	Power inductor	125°C ClassB	IEC60730-1/-2-11 IEC60335-1/-2-6	within appliance
CRCH serie		ELCO	Power inductor	125°C ClassB	IEC60730-1/-2-11 IEC60335-1/-2-6	within appliance
DR Series		Coiltronics	SMT Power Inductor	125°C ClassB	IEC60730-1/-2-11 IEC60335-1/-2-6	within appliance
DRA Series		Coiltronics	SMT Power Inductor	155°C ClassH	IEC60730-1/-2-11 IEC60335-1/-2-6	within appliance
Choque		Würth	Power inductors	125°C ClassF	IEC60730-1/-2-11 IEC60335-1/-2-6	within appliance
Distance holders		Richco	GREENAMID 6 G20 V0	GREENAMID 6 G20 V0 H NATURALE 105°C	IEC60730-1/-2-11 IEC60335-1/-2-6	within appliance
Distance holders		Marma		TECHNYL A20 (Rodia) PA-66	IEC60730-1/-2-11 IEC60335-1/-2-6	within appliance

27.2.3	TABLE: blocked output test				Verdict
	thermocouple locations	max. temperature measured, (°C)		Limit (°C)	
		2 nd hour	24 th hour		
	---	---	---	---	---
	---	---	---	---	---
	---	---	---	---	---
	---	---	---	---	---

27.3	TABLE: over-voltage and under-voltage test				Verdict
	test	operating condition	rated voltage (V)	test voltage 85/110% (V)	temperature (°C)
	Overvoltage transformer	T _{max}	---	---	---
	Undervoltage transformer	T _{max}	---	---	---
	Overvoltage valve	T _{min}	---	---	---
	Undervoltage valve	T _{min}	---	---	---